

Tracer AN Series

—MPPT Solar Charge Controller

User Manual



Models:

Tracer1206AN/Tracer2206AN

Tracer1210AN/Tracer2210AN

Tracer3210AN/Tracer4210AN

Important Safety Instructions

Please keep this manual for future review.

This manual contains all instructions of safety, installation and operation for Tracer AN series Maximum Power Point Tracking (MPPT) controller ("the controller" as referred to in this manual).

General Safety Information

- Read carefully all the instructions and warnings in the manual before installation.
- No user serviceable components inside the controller. DO NOT disassemble or attempt to repair the controller.
- Mount the controller indoors. Avoid exposure the components and do not allow water to enter the controller.
- Install the controller in a well ventilated place. The controller's heat sink may become very hot during operation.
- Suggest installing appropriate external fuses/breakers.
- Make sure to switch off all PV array connections and the battery fuse/breakers before controller installation and adjustment.
- Power connections must remain tight to avoid excessive heating from loose connection.

CONTENTS

1. General Information	1
1.1 Overview	1
1.2 Characteristics	2
1.3 Naming Rules of Controller models	2
1.4 Maximum Power Point Tracking Technology	3
1.5 Battery Charging Stage	4
2. Installation Instructions	7
2.1 General Installation Notes	7
2.2 PV Array Requirements	7
2.3 Wire Size	10
2.4 Mounting	11
3. Operation	14
3.1 Button	14
3.2 Interface	14
3.3 Setting	16
3.4 Accessories (optional)	21
4. Protections, Troubleshooting and Maintenance	23
4.1 Protection	23
4.2 Troubleshooting	24
4.3 Maintenance	24
5. Technical Specifications	26
Annex I Conversion Efficiency Curves	28
Annex II Mechanical Dimension Diagram	34

1. General Information

1.1 Overview

Tracer AN series controller is based on common negative design and advanced MPPT control algorithm, with LCD displaying running status, this product is artistic, economical and practical. The MPPT control algorithm can minimize the maximum power point loss rate and loss time, quickly track the maximum power point of the PV array and obtain the maximum energy from solar modules under any conditions; and can increase the ratio of energy utilization in the solar system by 20%-30% compared with a PWM charging method.

Limiting the charging power & current and reducing charging power functions ensure the system stable with over PV modules in high temperature environment. and increase the professional protection chip for the RS485 port, further improving the reliability and meeting the different application requirements.

Tracer AN series controller owns self-adaptive three-stage charging mode based on digital control circuit, which can effectively prolong the lifespan of battery and significantly improve the system performance. It also has comprehensive electronic protection for overcharge, overdischarge, PV & battery reverse etc, to ensure the solar system more reliable and more durable. This controller can be widely used for RV, communication base station, household system, field monitoring and many other areas.

Features:

- 100% charging and discharging in working environment temperature
- High quality and low failure rate components(ST/IR/Infineon) to ensure service life
- Advanced MPPT technology, with efficiency no less than 99.5%
- Maximum DC/DC conversion efficiency of 98%
- Ultra-fast tracking speed and guaranteed tracking efficiency
- Advanced MPPT control algorithm to minimize the MPP loss rate and loss time
- Accurate recognition and tracking of multiple-peaks maximum power point
- Wide MPP operating voltage range
- Limit charging power & current over rated range
- Support the lead-acid and lithium batteries with the needed tem. compensation
- Real-time energy statistics function
- Power reduction automatically over temperature range
- Multiple load work modes
- Comprehensive electronic protection
- RS485 with 5V/100mA protected output for no power devices, with Modbus
- Monitor and set the parameters via APP or PC software

1.2 Characteristics

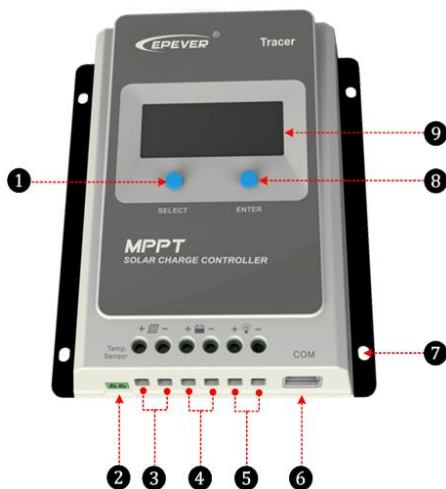

Figure 1 Product Characteristics

①	SELECT button	⑥	RS485 communication port
②	RTS* port	⑦	Mounting Hole Φ5mm
③	PV Terminals	⑧	ENTER button
④	Battery Terminals	⑨	LCD
⑤	Load Terminals		

★If the temperature sensor is short-circuited or damaged, the controller will charge or discharge at the default temperature setting of 25 °C.

1.3 Naming Rules of Controller models

EXAMPLE:

Tracer 1 2 10 AN

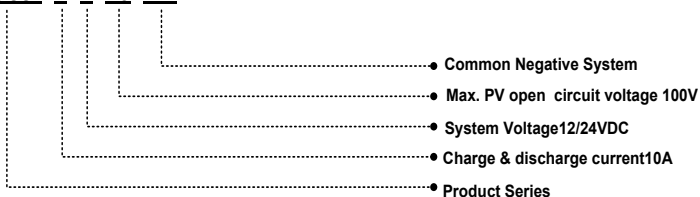

1.4 Maximum Power Point Tracking Technology

Due to the nonlinear characteristics of solar array, there is a maximum energy output point (Max Power Point) on its curve. Traditional controllers, with switch charging technology and PWM charging technology, can't charge the battery at the maximum power point, so can't harvest the maximum energy available from PV array, but the solar charge controller with Maximum Power Point Tracking (MPPT) Technology can lock on the point to harvest the maximum energy and deliver it to the battery.

The MPPT algorithm of our company continuously compares and adjusts the operating points to attempt to locate the maximum power point of the array. The tracking process is fully automatic and does not need user adjustment.

As the Figure 1-2, the curve is also the characteristic curve of the array, the MPPT technology will 'boost' the battery charge current through tracking the MPP. Assuming 100% conversion efficiency of the solar system, in that way, the following formula is established:

$$\text{Input power (P}_{PV}\text{)} = \text{Output power (P}_{\text{Bat}}\text{)}$$



$$\text{Input voltage (V}_{MPP}\text{)} * \text{input current (I}_{PV}\text{)} = \text{Battery voltage (V}_{\text{Bat}}\text{)} * \text{battery current (I}_{\text{Bat}}\text{)}$$

Normally, the V_{MPP} is always higher than V_{Bat} . Due to the principle of conservation of energy, the I_{Bat} is always higher than I_{PV} . The greater the discrepancy between V_{MPP} & V_{Bat} , the greater the discrepancy between I_{PV} & I_{Bat} . The greater the discrepancy between array and battery, the bigger reduction of the conversion efficiency of the system, thus the controller's conversion efficiency is particularly important in the PV system.

Figure 1-2 is the maximum power point curve, the shaded area is charging range of traditional solar charge controller (PWM Charging Mode), it can obviously diagnose the usage of the solar energy resource. According to our test, the MPPT controller can raise 20%-30% efficiency compared to the PWM controller. (Value may be fluctuant due to the influence of the ambient circumstance and energy loss.)

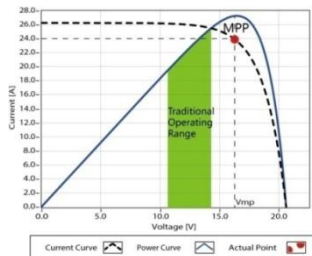

Figure 1-2 Maximum Power Point Curve

In actual application, as shading from cloud, tree and snow, the panel maybe appear Multi-MPP, but in actually there is only one real Maximum Power Point. As the below Figure 1-3 shows:

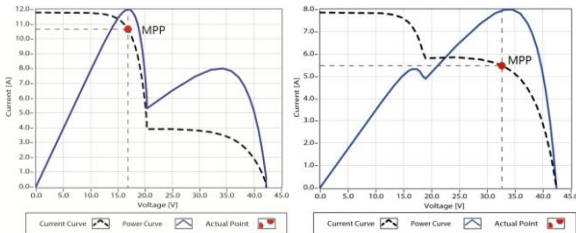

Figure 1-3 Mutil-MPP Curve

If the program works improperly after appearing Multi-MPP, the system will not work on the real max power point, which may waste most solar energy resources and seriously affect the normal operation of the system. The typical MPPT algorithm, designed by our company, can track the real MPP quickly and accurately, improve the utilization rate of the array and avoid the waste of resources.

1.5 Battery Charging Stage

The controller has a 3 stages battery charging algorithm (Bulk Charging, Constant Charging and Float Charging) for rapid, efficient, and safe battery charging.

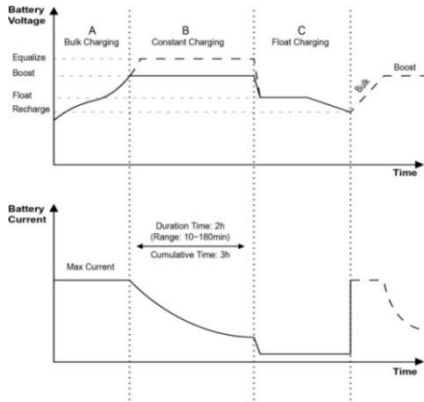

Figure 1-4 Battery changing stage Curve

A) Bulk Charging

In this stage, the battery voltage has not yet reached constant voltage (Equalize or Boost Voltage), the controller operates in constant current mode, delivering its maximum current to the batteries (MPPT Charging).

B) Constant Charging

When the battery voltage reaches the constant voltage setpoint, the controller will start to operate in constant charging mode, this process is no longer MPPT charging, and in the meantime the charging current will drop gradually, the process is not the MPPT charging. The Constant Charging has 2 stages, equalize and boost. These two stages are not carried out constantly in a full charge process to avoid too much gas precipitation or overheating of battery.

➤ Boost Charging

The Boost stage maintain 2 hours in default, user can adjust the constant time and preset value of boost voltage according to demand.

The stage is used to prevent heating and excessive battery gassing.

➤ Equalize Charging



WARNING: Explosive Risk!

Equalizing flooded battery would produce explosive gases, so well ventilation of battery box is recommended.



CAUTION: Equipment damage!

Equalization may increase battery voltage to the level that damages sensitive DC loads. Verify that all load allowable input voltages are 11% greater than the equalizing charging set point voltage.



CAUTION: Equipment damage!

Over-charging and excessive gas precipitation may damage the battery plates and activate material shedding on them. Too high an equalizing charge or for too long may cause damage.

Please carefully review the specific requirements of the battery used in the system.

Some types of batteries benefit from equalizing charge on a regular basis, which is able to stir electrolyte, balance battery voltage and accomplish chemical reaction. Equalizing charge increases battery voltage, higher than the standard complement voltage, which gasifies the battery electrolyte.

The controller will equalize the battery on 28th each month. The constant equalization period is 0~180 minutes. If the equalization isn't accomplished in one-time, the equalization recharge time will be accumulated until the set time is finished. Equalize charge and boost charge are not carried out constantly in a full charge process to avoid too much gas precipitation or overheating of battery.

NOTE:

1) Due to the influence of ambient circumstance or load working, the battery voltage can't be steady in constant voltage, controller will accumulate and

calculate the time of constant voltage working. When the accumulated time reach to 3 hours, the charging mode will turn to Float Charging.

2) If the controller time is not adjusted, the controller will equalize charge battery once every month following the inner time.

C) Float Charging

After the Constant voltage stage, the controller will reduce charging current to Float Voltage setpoint. This stage will have no more chemical reactions and all the charge current transforms into heat and gas at this time. Then the controller reduces the voltage to the floating stage, charging with a smaller voltage and current. It will reduce the temperature of the battery and prevent the gassing and charging the battery slightly at the same time. The purpose of Float stage is to offset the power consumption caused by self consumption and small loads in the whole system, while maintaining full battery storage capacity.

In Float charging stage, loads are able to obtain almost all power from solar panel. If loads exceed the power, the controller will no longer be able to maintain battery voltage in Float charging stage. If the battery voltage remains below the Recharge Voltage, the system will leave Float charging stage and return to Bulk charging stage.

2. Installation Instructions

2.1 General Installation Notes

- Please read the entire installation instructions to get familiar with the installation steps before installation.
- Be very careful when installing the batteries, especially flooded lead-acid battery. Please wear eye protection, and have fresh water available to wash and clean any contact with battery acid.
- Keep the battery away from any metal objects, which may cause short circuit of the battery.
- Explosive battery gases may come out from the battery during charging, so make sure ventilation condition is good.
- Ventilation is highly recommended if mounted in an enclosure. Never install the controller in a sealed enclosure with flooded batteries! Battery fumes from vented batteries will corrode and destroy the controller circuits.
- Loose power connections and corroded wires may result in high heat that can melt wire insulation, burn surrounding materials, or even cause fire. Ensure tight connections and use cable clamps to secure cables and prevent them from swaying in mobile applications.
- Lead-acid battery and lithium battery are recommended, other kinds please refer to the battery manufacturer.
- Battery connection may be wired to one battery or a bank of batteries. The following instructions refer to a singular battery, but it is implied that the battery connection can be made to either one battery or a group of batteries in a battery bank.
- Multiple same models of controllers can be installed in parallel on the same battery bank to achieve higher charging current. Each controller must have its own solar module(s).
- Select the system cables according to $5A/mm^2$ or less current density in accordance with Article 690 of the National Electrical Code, NFPA 70.

2.2 PV Array Requirements

(1) Serial connection (string) of PV modules

As the core component of PV system, controller could be suitable for various types of PV modules and maximize converting solar energy into electrical energy. According to the open circuit voltage (V_{oc}) and the maximum power point voltage (V_{MPP}) of the MPPT controller, the series number of different types PV modules can be calculated. The below table is for reference only.

Tracer1206/2206AN:

System voltage	36 cell Voc<23V		48 cell Voc<31V		54 cell Voc<34V		60 cell Voc<38V	
	Max.	Best	Max.	Best	Max.	Best	Max.	Best
12V	2	2	1	1	1	1	1	1
24V	2	2	-	-	-	-	-	-

System voltage	72 cell Voc<46V		96 cell Voc<62V		Thin-Film Module Voc>80V
	Max.	Best	Max.	Best	
12V	1	1	-	-	-
24V	1	1	-	-	-

NOTE: The above parameter values are calculated under standard test conditions (STC (Standard Test Condition): Irradiance 1000W/m², Module Temperature 25°C, Air Mass1.5.)

Tracer1210/2210/3210/4210AN:

System voltage	36 cell Voc<23V		48 cell Voc<31V		54 cell Voc<34V		60 cell Voc<38V	
	Max.	Best	Max.	Best	Max.	Best	Max.	Best
12V	4	2	2	1	2	1	2	1
24V	4	3	2	2	2	2	2	2

System voltage	72 cell Voc<46V		96 cell Voc<62V		Thin-Film Module Voc>80V
	Max.	Best	Max.	Best	
12V	2	1	1	1	1
24V	2	1	1	1	1

NOTE: The above parameter values are calculated under standard test conditions (STC (Standard Test Condition): Irradiance 1000W/m², Module Temperature 25°C, Air Mass1.5.)

(2) Maximum PV array power

The MPPT controller has the function of current/power-limiting, that is, during the charging process, when the charging current or power exceeds the rated charging current or power, the controller will automatically limit the charging current or power to the rated charging current or power, which can effectively protect the charging parts of controller, and prevent damages to the controller due to the connection of some over-specification PV modules. The actual operation of PV array is as follows:

Condition 1:

Actual charging power of PV array ≤ Rated charging power of controller

Condition 2:

Actual charging current of PV array ≤ Rated charging current of controller

When the controller operates under “**Condition 1**” or “**Condition 2**”, it will carry out the charging as per the actual current or power; at this time, the controller can work at the maximum power point of PV array.



WARNING: When the power of PV is not greater than the rated charging power, but the maximum open-circuit voltage of PV array is more than 60V(Tracer**06AN)/100V(Tracer**10AN) (at the lowest environmental temperature), the controller may be damaged.

Condition 3:

Actual charging power of PV array > Rated charging power of controller

Condition 4:

Actual charging current of PV array > Rated charging current of controller

When the controller operates under “**Condition 3**” or “**Condition 4**”, it will carry out the charging as per the rated current or power.



WARNING: When the power of PV module is greater than the rated charging power, and the maximum open-circuit voltage of PV array is more than 60V(Tracer**06AN)/100V(Tracer**10AN) (at the lowest environmental temperature), the controller may be damaged.

According to “Peak Sun Hours diagram”, if the power of PV array exceeds the rated charging power of controller, then the charging time as per the rated power will be prolonged, so that more energy can be obtained for charging the battery. However, in the practical application, the maximum power of PV array shall be not greater than 1.5 x the rated charging power of controller. If the maximum power of PV array exceeds the rated charging power of controller too much, it will not only cause the waste of PV modules, but also increase the open-circuit voltage of PV array due to the influence of environmental temperature, which may make the probability of damage to the controller rise. Therefore, it is very important to configure the system reasonably. For the recommended maximum power of PV array for this controller, please refer to the table below:

Model	Rated Charge Current	Rated Charge Power	Max. PV Array Power	Max. PV open circuit voltage
Tracer1206AN	10A	130W/12V 260W/24V	195W/12V 390W/24V	46V ^① 60V ^②
Tracer2206AN	20A	260W/12V 520W/24V	390W/12V 780W/24V	
Tracer1210AN	10A	130W/12V 260W/24V	195W/12V 390W/24V	92V ^① 100V ^②
Tracer2210AN	20A	260W/12V 520W/24V	390W/12V 780W/24V	
Tracer3210AN	30A	390W/12V 780W/24V	580W/12V 1170W/24V	
Tracer4210AN	40A	520W/12V 1040W/24V	780W/12V 1560W/24V	

①At 25°C environment temperature

②At minimum operating environment temperature

2.3 Wire Size

The wiring and installation methods must conform to all national and local electrical code requirements.

➤ PV Wire Size

Since PV array output can vary due to the PV module size, connection method or sunlight angle, the minimum wire size can be calculated by the I_{sc}^* of PV array. Please refer to the value of I_{sc} in the PV module specification. When PV modules connect in series, the I_{sc} is equal to a PV modules I_{sc} . When PV modules connect in parallel, the I_{sc} is equal to the sum of the PV module' s I_{sc} . The I_{sc} of the PV array must not exceed the controller' s maximum PV input current. Please refer to the table as below:

NOTE: All PV modules in a given array are assumed to be identical.

* I_{sc} =short circuit current(amps) V_{oc} =open circuit voltage.

Model	Max. PV input current	Max. PV wire size*
Tracer1206AN Tracer1210AN	10A	4mm ² /12AWG
Tracer2206AN Tracer2210AN	20A	6mm ² /10AWG
Tracer3210AN	30A	10mm ² /8AWG
Tracer4210AN	40A	16mm ² /6AWG

* These are the maximum wire sizes that will fit the controller terminals.



CAUTION: When the PV modules connect in series, the open circuit voltage of the PV array must not exceed 46V (Tracer**06AN), 92V (Tracer**10AN) at 25°C environment temperature.

➤ Battery and Load Wire Size

The battery and load wire size must conform to the rated current, the reference size as below:

Model	Rated charge current	Rated discharge current	Battery wire size	Load wire size
Tracer1206AN Tracer1210AN	10A	10A	4mm ² /12AWG	4mm ² /12AWG
Tracer2206AN Tracer2210AN	20A	20A	6mm ² /10AWG	6mm ² /10AWG
Tracer3210AN	30A	30A	10mm ² /8AWG	10mm ² /8AWG
Tracer4210AN	40A	40A	16mm ² /6AWG	16mm ² /6AWG



CAUTION: The wire size is only for reference. If there is a long distance between the PV array and the controller and between the controller and the battery, larger wires can be used to reduce the voltage drop and improve performance.



CAUTION: For the battery, the recommended wire will be selected according to the conditions that its terminals are not connected to any additional inverter.

2.4 Mounting



WARNING: Risk of explosion! Never install the controller in a sealed enclosure with flooded batteries! Do not install in a confined area where battery gas can accumulate.



WARNING: Risk of electric shock! When wiring the solar modules, the PV array can produce a high open circuit voltage, so turn off the breaker before wiring and be careful when wiring.



CAUTION: The controller requires at least 150mm of clearance above and below for proper air flow. Ventilation is highly recommended if mounted in an enclosure.

Installation Procedure:

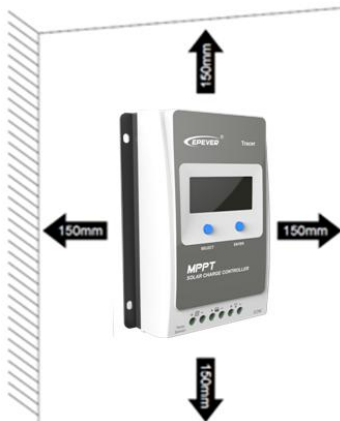

Figure 2-1 Mounting

Step 1: Determination of Installation Location and Heat-dissipation Space

Determination of installation location: The controller shall be installed in a place with sufficient air flow through the radiators of the controller and a minimum clearance of

150 mm from the upper and lower edges of the controller to ensure natural thermal convection. Please see Figure 2-1: Mounting



CAUTION: If the controller is to be installed in an enclosed box, it is important to ensure reliable heat dissipation through the box.

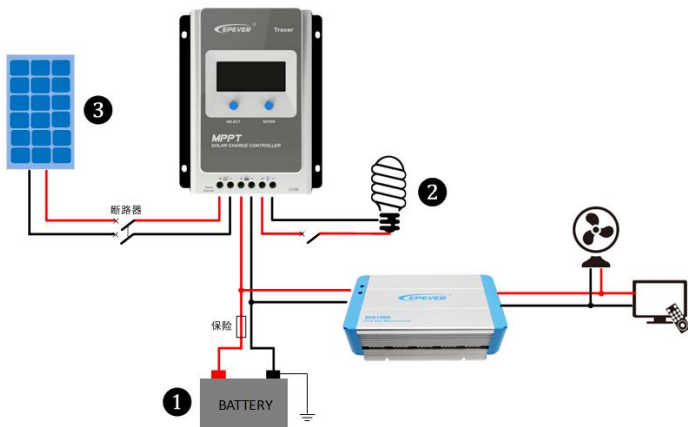

Figure 2-2 Schematic of wiring diagram

Step 2: Connect the system in the order of ① battery → ② load → ③ PV array in accordance with Figure 2-2, "Schematic Wiring Diagram" and disconnect the system in the reverse order ③ ② ①.



CAUTION: While wiring the controller do not close the circuit breaker or fuse and make sure that the leads of "+" and "-" poles are connected correctly.



CAUTION: A fuse which current is 1.25 to 2 times the rated current of the controller, must be installed on the battery side with a distance from the battery not greater than 150 mm.



CAUTION: If the controller is to be used in an area with frequent lightning strikes or unattended area, it must install an external surge arrester.



CAUTION: If an inverter is to be connected to the system, connect the inverter directly to the battery, not to the load side of the controller.

Step 3: Grounding

Tracer AN series is a common-negative controller, where all the negative terminals of PV array, battery and load can be grounded simultaneously or any one of them will be grounded. However, according to the practical application, all the negative terminals

of PV array, battery and load can also be ungrounded, but the grounding terminal on its shell must be grounded, which may effectively shield the electromagnetic interference from the outside, and prevent some electric shock to human body due to the electrification of the shell.



CAUTION: For common-negative system, such as motorhome, it is recommended to use a common-negative controller; but if in the common-negative system, some common-positive equipment are used, and the positive electrode is grounded, the controller may be damaged.

Step 4: Connect accessories

- Connect the remote temperature sensor cable



Temperature Sensor

(Model:RT-MF58R47K3.81A)



Remote Temperature Sensor Cable (Optional)

(Model:RTS300R47K3.81A)

Connect the remote temperature sensor cable to the interface ② and place the other end close to the battery.



CAUTION: If the remote temperature sensor is not connected to the controller,, the default setting for battery charging or discharging temperature is 25 °C without temperature compensation.

- Connect the accessories for RS485 communication

Refer to chapter 3.3 “Setting”



CAUTION: RS485 communication port's internal circuit has no isolation design, so a communication isolator is recommended to connect to the interface before communicating.

Step 5: Powered on the controller

Closing the battery fuse will switch on the controller. Then check the status of the battery indicator (the controller is operating normally when the indicator is lit in green). Close the fuse and circuit breaker of the load and PV array. Then the system will be operating in the preprogrammed mode.



CAUTION: If the controller is not operating properly or the battery indicator on the controller shows an abnormality, please refer to 4.2 “Troubleshooting”.

3. Operation

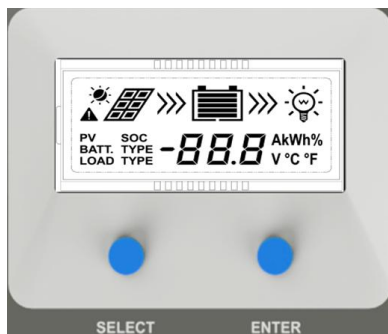

3.1 Button





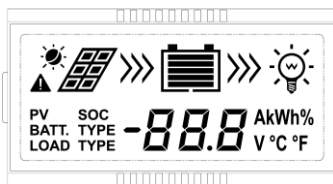



Mode	Note
Load ON/OFF	In load manual mode, it can turn the load On/Off via the “ENTER” button.
Clear Fault	Press the “ENTER” button.
Browsing Mode	Press the “SELECT” button.
Setting Mode	Press the “ENTER” button. and hold on 5s to enter the setting mode Press the “SELECT” button. to set the parameters, Press the “ENTER” button. to confirm the setting parameters or no operation for 10s, it will exit the setting interface automatically.

3.2 Interface











1) Status Description

Item	Icon	Status
PV array		Day

		Night
	 	No charging
	 	Charging
	PV	PV Voltage, Current, Power
Battery		Battery capacity, In Charging
	BATT.	Battery Voltage, Current, Temperature
	BATT. TYPE	Battery Type
Load		Load ON
		Load OFF
	LOAD	Current/Consumed energy/Load mode

2) Fault Indication

Status	Icon	Description
Battery over discharged	 	Battery level shows empty, battery frame blink, fault icon blink
Battery over voltage	 	Battery level shows full, battery frame blink, fault icon blink
Battery over temperature	 	Battery level shows current value, battery frame blink, fault icon blink
Load failure	 	Load overload ^① , Load short circuit

①When load current reaches 1.02-1.05 times, 1.05-1.25 times, 1.25-1.35 times and 1.35-1.5 times more than nominal value, controller will automatically turn off loads in 50s, 30s, 10s and 2s respectively.

3) Browse interface

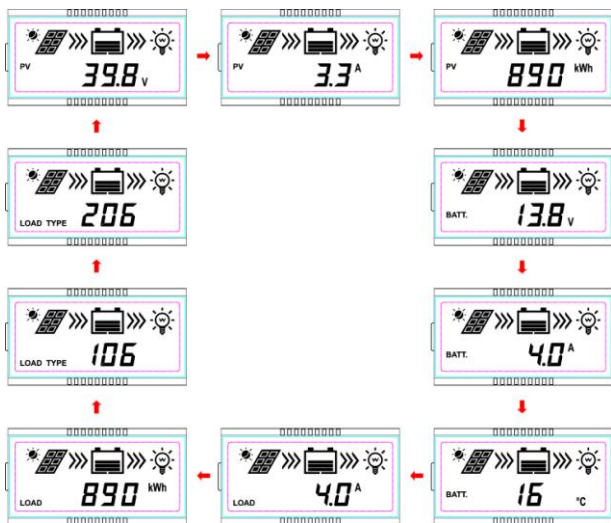

3.3 Setting

1) Clear the generated energy

Operation:

Step 1: Press the “ENTER” button and hold 5s under the PV generated energy interface and the value will be flashing.

Step 2: Press the “ENTER” button to clear the generated energy..

2) Switch the battery temperature unit

Press the “ENTER” button and hold 5s under the battery temperature interface.

3) Battery type

① Battery type

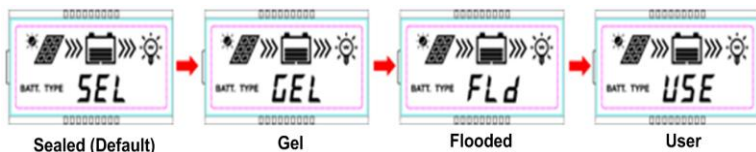

Item	Lead-acid battery	Lithium battery
1	Sealed(default)	LiFePO ₄ (4s/12V; 8s/24V)
2	Gel	Li(NiCoMn)O ₂ (3s/12V; 6s/24V)
3	Flooded	User(9~34V)
4	User(9~17V/12V; 18~34V/24V)	



CAUTION: When the default battery type is selected, the battery voltage control parameters will be set by default and can't be changed. To change these parameters, select "User" battery type.

Operation:

Step1: Press the "ENTER" button and hold 5s under the battery voltage interface.

Step2: Press the "SELECT" button when the battery type interface is flashing.

Step3: Press the "ENTER" button to confirm the battery type.



CAUTION: Please refer to chapter③ for the battery control voltage, when the battery type is User.

②Battery Voltage Control Parameters

Below parameters are in 12V system at 25 °C, please double the values in 24V system

Battery type	Sealed	Gel	Flooded	User
Over Voltage Disconnect Voltage	16.0V	16.0V	16.0V	9~17V
Charging Limit Voltage	15.0V	15.0V	15.0V	9~17V
Over Voltage Reconnect Voltage	15.0V	15.0V	15.0V	9~17V
Equalize Charging Voltage	14.6V	—	14.8V	9~17V
Boost Charging Voltage	14.4V	14.2V	14.6V	9~17V
Float Charging Voltage	13.8V	13.8V	13.8V	9~17V
Boost Reconnect Charging Voltage	13.2V	13.2V	13.2V	9~17V
Low Voltage Reconnect Voltage	12.6V	12.6V	12.6V	9~17V
Under Voltage Warning Reconnect Voltage	12.2V	12.2V	12.2V	9~17V
Under Voltage Warning Voltage	12.0V	12.0V	12.0V	9~17V
Low Voltage Disconnect Voltage	11.1V	11.1V	11.1V	9~17V
Discharging Limit Voltage	10.6V	10.6V	10.6V	9~17V
Equalize Duration	120 min	—	120 min	0~180 min
Boost Duration	120 min	120 min	120 min	10~180 min



CAUTION: Due to diversification of lithium battery types, its control voltage shall be confirmed with the engineer.

③ User settings

(1) PC setting

- Connection

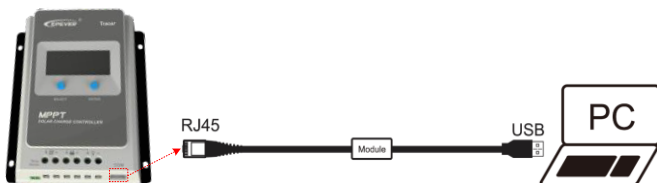

- Download software

<http://www.epever.com/en/index.php/Technical/download> (PC Software for the Solar Charge Controller)

(2) APP software setting

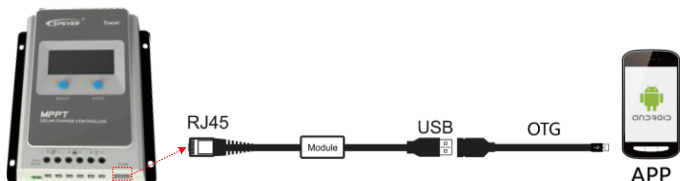

- Download software (User for lead-acid battery)

<http://www.epever.com/en/index.php/Technical/download> (Android APP for the Solar Charge Controller)

- Download software (User for lithium battery)

<http://www.epever.com/en/index.php/Technical/download> (Android APP for the Li-Battery Solar Charge Controller)

(3) Setting the control voltage value

- The following rules must be observed when modifying the parameter values in User for lead-acid battery.

I. Over Voltage Disconnect Voltage > Charging Limit Voltage ≥ Equalize Charging Voltage ≥ Boost Charging Voltage ≥ Float Charging Voltage > Boost Reconnect Charging Voltage.

II. Over Voltage Disconnect Voltage > Over Voltage Reconnect Voltage

III. Low Voltage Reconnect Voltage > Low Voltage Disconnect Voltage ≥ Discharging Limit Voltage.

IV. Under Voltage Warning Reconnect Voltage > Under Voltage Warning Voltage ≥ Discharging Limit Voltage.

V. Boost Reconnect Charging voltage > Low Voltage Reconnect Voltage.

- The following rules must be observed when modifying the parameter values in User for lithium battery.

I. Over Voltage Disconnect Voltage > Over charging protection voltage (Protection Circuit Modules (PCM)) + 0.2V[※];

II. Over Voltage Disconnect Voltage > Over Voltage Reconnect Voltage = Charging Limit Voltage ≥ Equalize Charging Voltage = Boost Charging Voltage ≥ Float Charging Voltage > Boost Reconnect Charging Voltage;

III. Low Voltage Reconnect Voltage > Low Voltage Disconnect Voltage ≥ Discharging Limit Voltage;

IV. Under Voltage Warning Reconnect Voltage > Under Voltage Warning Voltage ≥ Discharging Limit Voltage;

V. Boost Reconnect Charging voltage > Low Voltage Reconnect Voltage;

VI. Low Voltage Disconnect Voltage ≥ Over discharging protection voltage (PCM) + 0.2V[※];



WARNING: The required accuracy of PCM shall be at least 0.2V. If the deviation is higher than 0.2V, the manufacturer will assume no liability for any system malfunction caused by this.

4) Local load mode

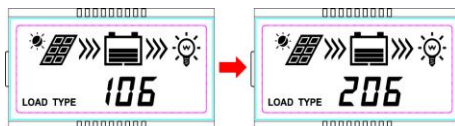

Operation:

Step1: Press the “ENTER” button and hold 5s under the load mode interface.

Step2: Press the “SELECT” button when the load mode interface is flashing.

Step3: Press the “ENTER” button to confirm the load mode..

NOTE: Please refer to chapter 4.2 for the load working modes.

① Load working mode

1**	Timer 1	2**	Timer 2
100	Light ON/OFF	2 n	Disabled
101	Load will be on for 1 hour after sunset	201	Load will be on for 1 hour before sunrise
102	Load will be on for 2 hours after sunset	202	Load will be on for 2 hours before sunrise
103 ~	Load will be on for 3 ~ 13 hours after sunset	203 ~	Load will be on for 3 ~ 13 hours before sunrise

113		213	
114	Load will be on for 14 hours after sunset	214	Load will be on for 14 hours before sunrise
115	Load will be on for 15 hours after sunset	215	Load will be on for 15 hours before sunrise
116	Test mode	2 n	Disabled
117	Manual mode(Default load ON)	2 n	Disabled



CAUTION: Please set Light ON/OFF, Test mode and Manual mode via Timer1. Timer2 will be disabled and display "2 n".

②Load working mode settings

(1)PC setting

- Connection

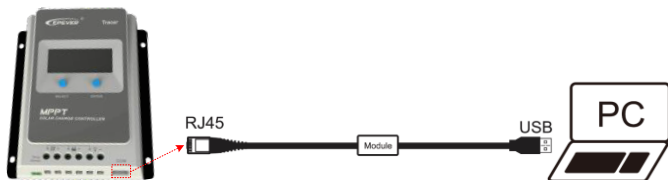

- Download software

<http://www.epever.com/en/index.php/Technical/download> (PC Software for the Solar Charge Controller)

(2)APP software setting

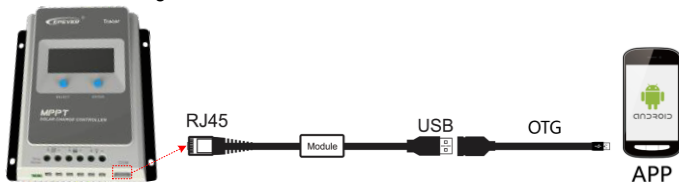

- Download software







<http://www.epever.com/en/index.php/Technical/download> (Android APP for the Solar Charge Controller)

(3)MT50 Setting



CAUTION: For detailed setting methods, please refer to the instructions or contact after-sales support.

3.4 Accessories (optional)

<p>Remote Temperature Sensor (RTS300R47K3.81A)</p>		<p>Acquisition of battery temperature for undertaking temperature compensation of control parameters, the standard length of the cable is 3m (length can be customized). The RTS300R47K3.81A connects to the port (4th) on the controller. NOTE: The temperature sensor short-circuited or damaged, the controller will be charging or discharging at the default temperature 25 °C.</p>
<p>USB to RS485 cable CC-USB-RS485-150U</p>		<p>USB to RS485 converter is used to monitor each controller using Solar Station PC software. The length of cable is 1.5m. TheCC-USB-RS485-150U connects to the RS485 Port on the controller.</p>
<p>OTG cable OTG-12CM</p>		<p>Used to connect the controller with mobile phone and able to achieve real-time monitoring of the controller and modification of the parameters by using mobile APP software</p>
<p>Remote Meter MT50</p>		<p>MT50 can display various operating data and fault info the system. The information can be displayed on a backlit LCD screen, the buttons are easy-to-operate, and the numeric display is readable.</p>
<p>WIFI Serial Adapter eBox-WIFI-01</p>		<p>After the controller is connected with the eBox-WIFI-01 through the standard Ethernet cable (parallel cable), the operating status and related parameters of the controller can be monitored by the mobile APP software through WIFI signals.</p>
<p>RS485 to Bluetooth Adapter eBox-BLE-01</p>		<p>After the controller is connected with the eBox-BLE-01 through the standard Ethernet cable (parallel cable), the operating status and related parameters of the controller can be monitored by the mobile APP software through Bluetooth signals.</p>
<p>Logger eLOG01</p>		<p>After the controller is connected with the eLOG-01 through the RS485 communication cable, it can record the operating data of the controller or monitor the real-time operating status of the controller via PC software.</p>
<p>NOTE: For setting and operation of accessory, please refer to accessory's user manual.</p>		

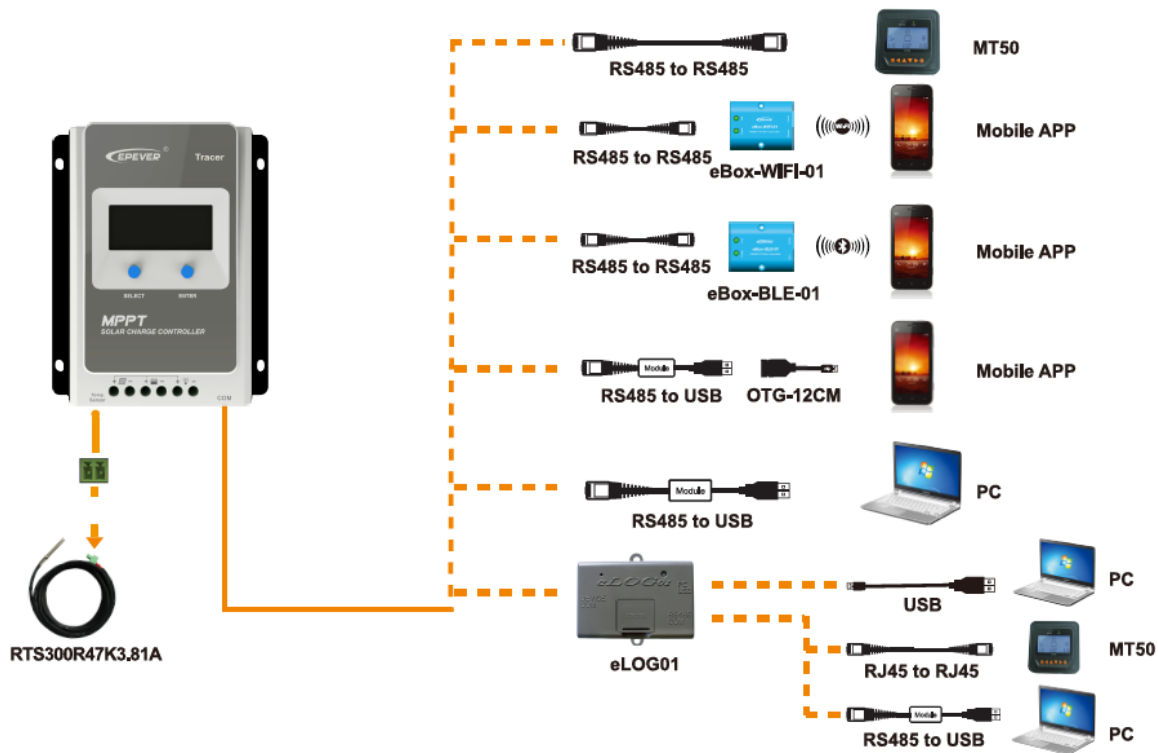











4. Protections, Troubleshooting and Maintenance

4.1 Protection

PV Over Current/power	When the charging current or power of the PV array exceeds the controller's rated current or power, it will be charged at the rated current or power. NOTE: When the PV modules are in series, ensure that the open-circuit voltage of the PV array does not exceed the "maximum PV open-circuit voltage" rating. Otherwise the controller may be damaged.
PV Short Circuit	When not in PV charging state, the controller will not be damaged in case of a short-circuiting in the PV array.
PV Reverse Polarity	When the polarity of the PV array is reversed, the controller may not be damaged and can continue to operate normally after the polarity is corrected. NOTE: If the PV array is reverse connected to the controller, 1.5 times rated controller power (watts) from the PV array, will damage the controller.
Night Reverse Charging	Prevents the battery from discharging through the PV module at night.
Battery Reverse Polarity	Fully protected against battery reverse polarity; no damage will occur for the battery. Correct the miswire to resume normal operation. NOTE: Limited to the characteristic of lithium battery, when the PV connection is correct and battery connection reversed, the controller will be damaged.
Battery Over Voltage	When the battery voltage reaches the over voltage disconnect voltage, it will automatically stop battery charging to prevent battery damage caused by over-charging.
Battery Over Discharge	When the battery voltage reaches the low voltage disconnect voltage, it will automatically stop battery discharging to prevent battery damage caused by over-discharging. (Any controller connected loads will be disconnected. Loads directly connected to the battery will not be affected and may continue to discharge the battery.)
Battery Overheating	The controller can detect the battery temperature through an external temperature sensor. The controller stops working when its temperature exceeds 65 °C and restart to work when its temperature is below 55 °C.
Lithium Battery Low Temperature	When the temperature detected by the optional temperature sensor is lower than the Low Temperature Protection Threshold(LTPT), the controller will stop charging and discharging automatically. When the detected temperature is higher than the LTPT, the controller will be working automatically (The LTPT is 0 °C by default and can be set within the range of 10 ~ -40 °C).
Load Short Circuit	When the load is short circuited (The short circuit current is ≥ 4 times the rated controller load current), the controller will automatically cut off the output. If the load reconnects the output automatically five times (delay of 5s, 10s, 15s, 20s, 25s), it needs to be cleared by pressing the Load button, restarting the controller or switching from Night to the Day (nighttime > 3 hours).
Load Overload	When the load is overloading (The overload current is ≥ 1.05 times the rated load current), the controller will automatically cut off the output. If the load reconnects automatically five times (delay of 5s, 10s, 15s, 20s, 25s), it needs to be cleared by pressing the Load button restarting the controller, switching from Night to Day (nighttime > 3 hours).
Controller Overheating★	The controller is able to detect the temperature inside the battery. The controller stops working when its temperature exceeds 85 °C and restart to work when its temperature is below 75 °C.
TVS High Voltage Transients	The internal circuitry of the controller is designed with Transient Voltage Suppressors (TVS) which can only protect against high-voltage surge pulses with less energy. If the controller is to be used in an area with frequent lightning strikes, it is recommended to install an external surge arrester.

★When the internal temperature is 81°C, the reducing power charging mode which reduce the charging power of 5%,10%,20%,40% every increase 1 °C is turned on. If the internal temperature is greater than 85°C, the controller will stop charging. When the temperature declines to be below 75 °C, the controller will resume.

4.2 Troubleshooting

Possible reasons	Faults	Troubleshooting
PV array disconnection	LCD display  during daytime when sunshine falls on PV modules properly	Confirm that PV wire connections are correct and tight.
Battery voltage is lower than 8V	Wire connection is correct, the controller is not working.	Please check the voltage of battery. At least 8V voltage to activate the controller.
Battery over voltage	  Battery level shows full, battery frame blink, fault icon blink	Check if battery voltage is higher than OVD(over voltage disconnect voltage), and disconnect the PV.
Battery over discharged	  Battery level shows empty, battery frame blink, fault icon blink	When the battery voltage is restored to or above LVR(low voltage reconnect voltage), the load will recover
Battery Overheating	  Battery level shows empty, battery frame blink, fault icon blink	The controller will automatically turn the system off. But while the temperature decline to be below 55 °C, the controller will resume.
Load Overload	1. The load is no output 2.  	①Please reduce the number of electric equipments. ②Restart the controller. ③wait for one night-day cycle (night time>3 hours).
Load Short Circuit	 Load and fault icon blink	①Check carefully loads connection, clear the fault. ②Restart the controller.

4.3 Maintenance

The following inspections and maintenance tasks are recommended at least two times per year for best performance.

- Make sure controller firmly installed in a clean and dry ambient.
- Make sure no block on air-flow around the controller. Clear up any dirt and fragments on radiator.
- Check all the naked wires to make sure insulation is not damaged for

- solarization, frictional wear, dryness, insects or rats etc. Repair or replace some wires if necessary.
- Tighten all the terminals. Inspect for loose, broken, or burnt wire connections.
- Check and confirm that LED is consistent with required. Pay attention to any troubleshooting or error indication .Take corrective action if necessary.
- Confirm that all the system components are ground connected tightly and correctly.
- Confirm that all the terminals have no corrosion, insulation damaged, high temperature or burnt/discolored sign, tighten terminal screws to the suggested torque.
- Check for dirt, nesting insects and corrosion. If so, clear up in time.
- Check and confirm that lightning arrester is in good condition. Replace a new one in time to avoid damaging of the controller and even other equipments.



WARNING: Risk of electric shock!

Make sure that all the power is turned off before above operations, and then follow the corresponding inspections and operations.

5. Technical Specifications

Electrical Parameters

Item	Tracer 1206AN	Tracer 2206AN	Tracer 1210AN	Tracer 2210AN	Tracer 3210AN	Tracer 4210AN
System nominal voltage	12/24VDC ^① Auto					
Rated charge current	10A	20A	10A	20A	30A	40A
Rated discharge current	10A	20A	10A	20A	30A	40A
Battery voltage range	8~32V					
Max. PV open circuit voltage	60V ^② 46V ^③		100V ^② 92V ^③			
MPP voltage range	(Battery voltage +2V)~ 36V		(Battery voltage +2V)~ 72V			
Max. PV input power	130W/12V 260W/24V	260W/12V 520W/24V	130W/12V 260W/24V	260W/12V 520W/24V	390W/12V 780W/24V	520W/12V 1040W/24V
Self-consumption	≤12mA					
Discharge circuit voltage drop	≤0.23V					
Temperature compensate coefficient ^④	-3mV/°C/2V (Default)					
Grounding	Common negative					
RS485 interface	5VDC/100mA					
LCD backlight time	Default:60S,Range:0~999S(0S:the backlight is ON all the time)					

①When a lithium battery is used, the system voltage can't be identified automatically.

②At minimum operating environment temperature

③At 25°C environment temperature

④When a lithium battery is used, the temperature compensate coefficient will be 0,and can't be changed.

Environmental Parameters

Working environment temperature [*]	-25°C~+45°C(100% input and output)
Storage temperature range	-20°C~+70°C
Relative humidity	≤95%, N.C.
Enclosure	IP30

◆The controller can full load working in the working environment temperature, When the internal temperature is 81°C, the reducing power charging mode is turned on. Refer to P24.

Mechanical Parameters

Item	Tracer1206AN Tracer1210AN	Tracer2206AN Tracer2210AN	Tracer3210AN	Tracer4210AN
Dimension	172x139 x 44mm	220x154x 52mm	228x164x55mm	252x180x63mm
Mounting dimension	130x130mm	170x145mm	170x164mm	210x171mm
Mounting hole size	Φ5mm			
Terminal	12AWG(4mm ²)	6AWG(16mm ²)	6AWG(16mm ²)	6AWG(16mm ²)
Recommended cable	12AWG(4mm ²)	10AWG(6mm ²)	8AWG(10mm ²)	6AWG(16mm ²)
Weight	0.57kg	0.94kg	1.26kg	1.65kg

Annex I Conversion Efficiency Curves

Illumination Intensity: 1000W/m² Temp: 25°C

Model: Tracer1206AN

1. Solar Module MPP Voltage(17V, 34V) / Nominal System Voltage(12V)

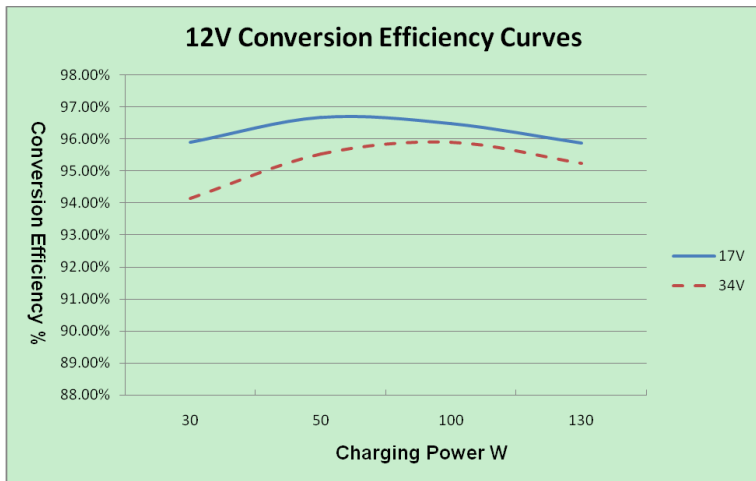

2. Solar Module MPP Voltage(34V,45V) / Nominal System Voltage(24V)

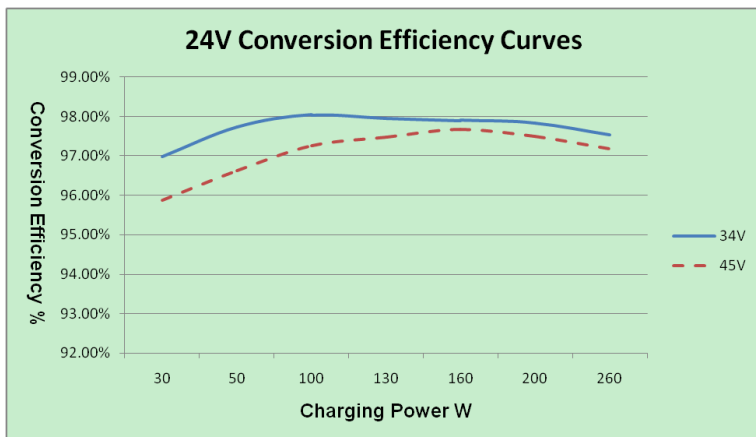

Model: Tracer1210AN

1. Solar Module MPP Voltage(17V, 34V) / Nominal System Voltage(12V)

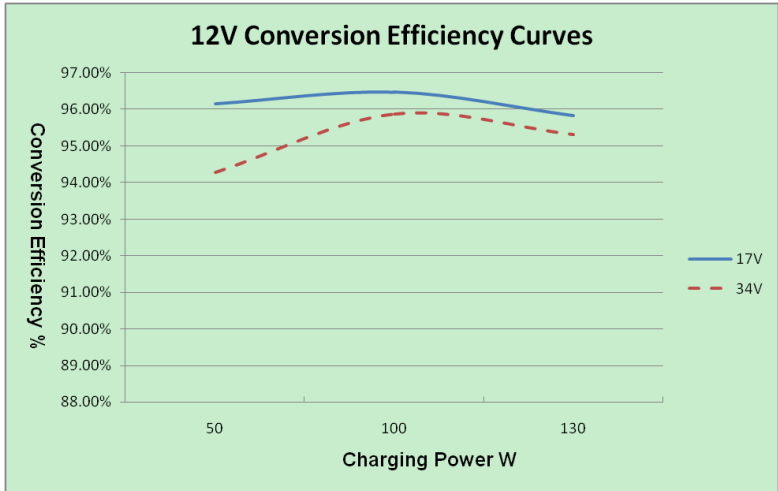

2. Solar Module MPP Voltage(34V,51V,68V) / Nominal System Voltage(24V)

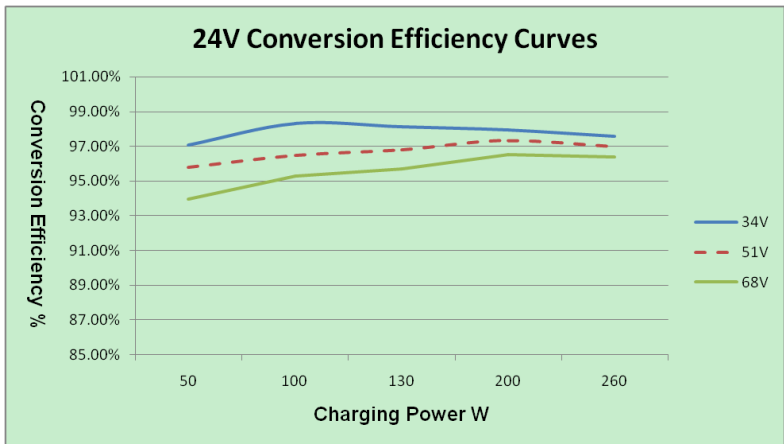

Model: Tracer2206AN

1. Solar Module MPP Voltage(17V, 34V) / Nominal System Voltage(12V)

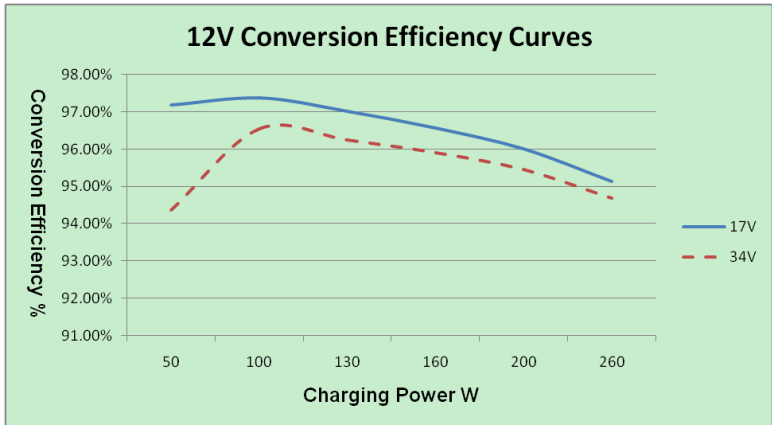

2. Solar Module MPP Voltage(34V,45V) / Nominal System Voltage(24V)

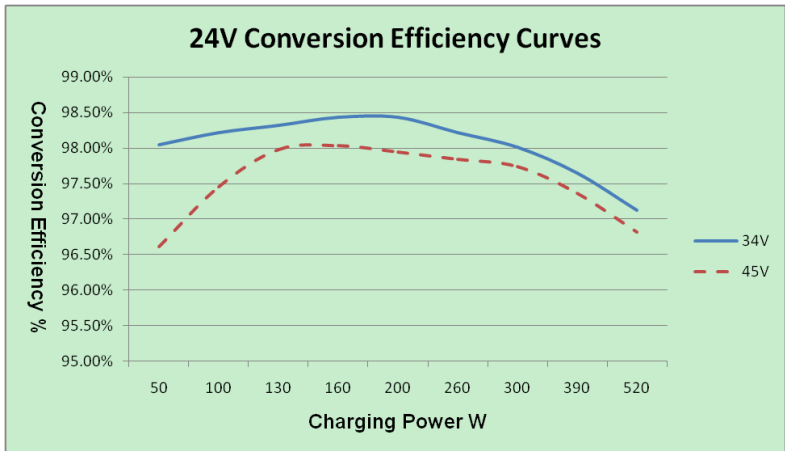

Model: Tracer2210AN

1. Solar Module MPP Voltage(17V, 34V) / Nominal System Voltage(12V)

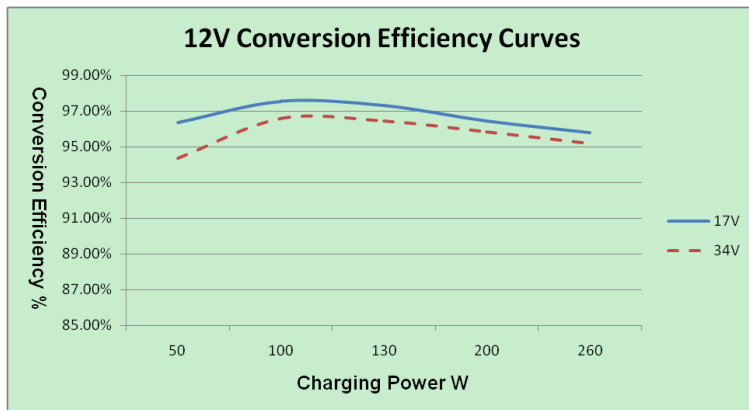

2. Solar Module MPP Voltage(34V,51V,68V) / Nominal System Voltage(24V)

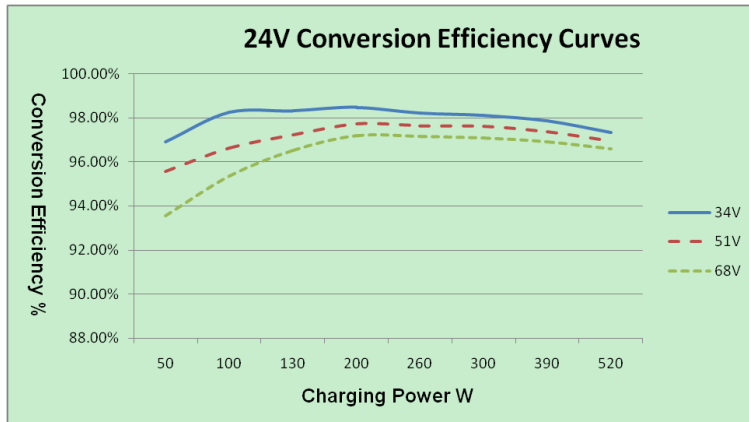

Model: Tracer3210AN

1. Solar Module MPP Voltage(17V, 34V) / Nominal System Voltage(12V)

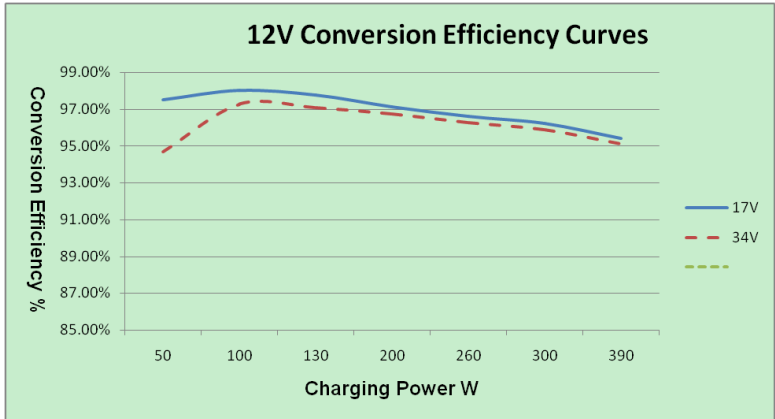

2. Solar Module MPP Voltage(34V,51V,68V) / Nominal System Voltage(24V)

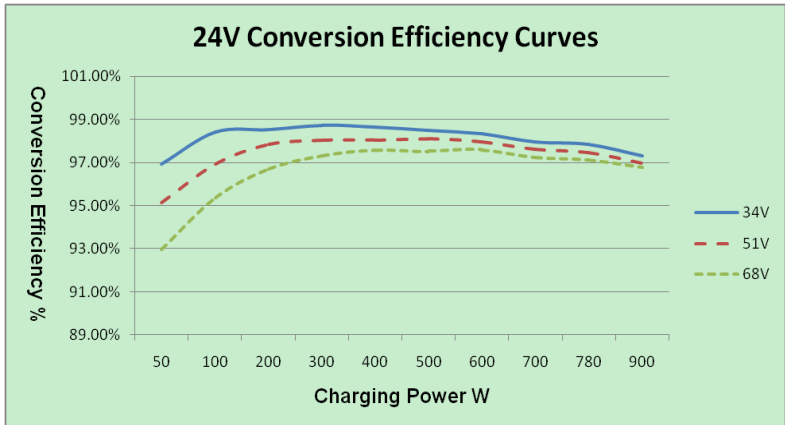

Model: Tracer4210AN

1. Solar Module MPP Voltage(17V, 34V) / Nominal System Voltage(12V)

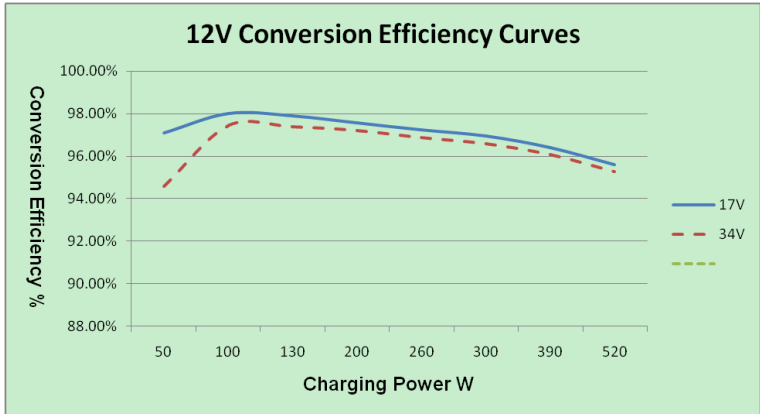

2. Solar Module MPP Voltage(34V,51V,68V) / Nominal System Voltage(24V)

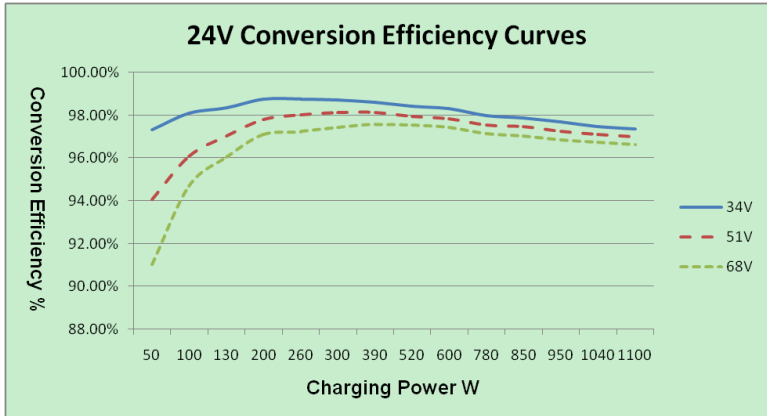

Tracer2206AN/2210AN (Unit: mm)

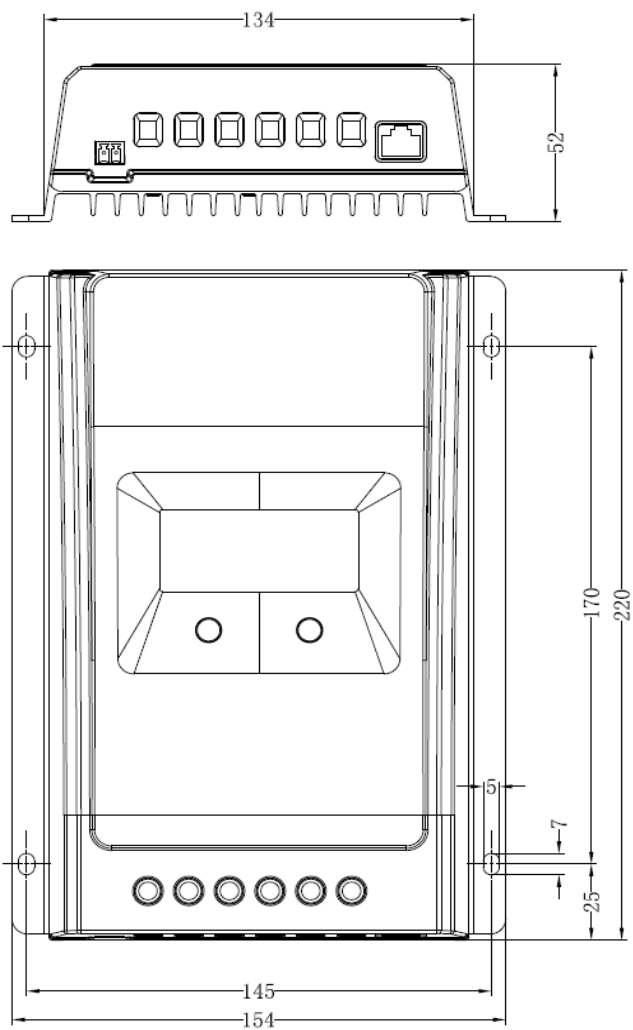

Tracer3210AN (Unit: mm)

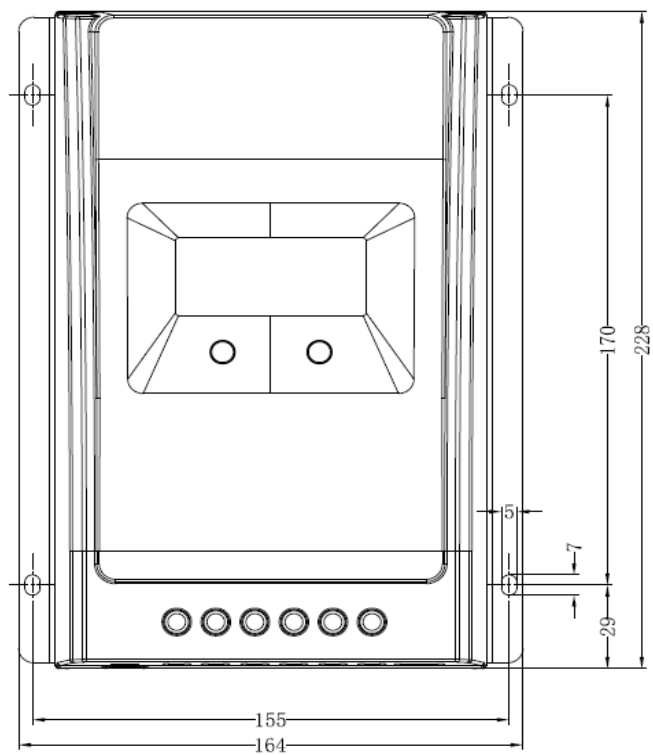
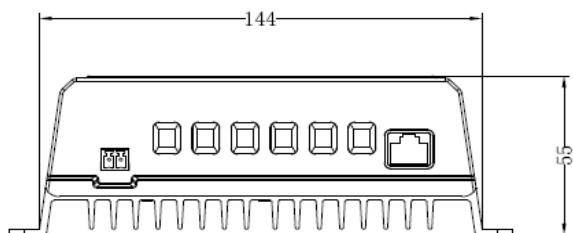

Tracer4210AN (Unit: mm)

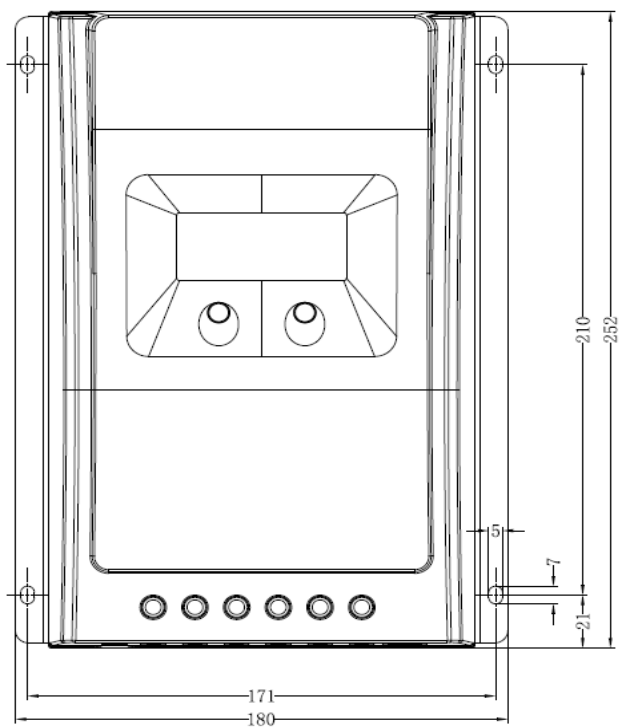
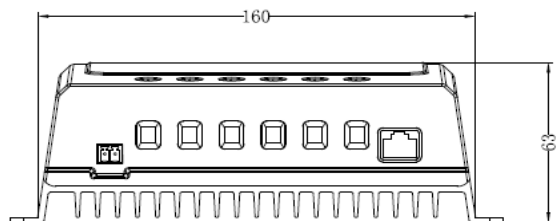

Any changes without prior notice!

Version number: 1.2