

# **Tricycle**

## **Installation instructions**

Dear Customer,

Thank you for choosing our tricycle. This manual will show you how to install your tricycle. Read the manual before installing your tricycle, Be sure to follow the sequence of steps carefully, and keep the manual handy for future reference. This manual contains important information regarding assembly of the tricycle but is not intended to be a complete or comprehensive manual. We recommend consulting a tricycle specialist if you have any doubts or concerns regarding your experience or ability to properly assemble and maintain the bicycle.

Please do not hesitate to get in touch by clicking "Contact Us" through your Amazon / eBay account.

## CONTENTS

Components Name .....	01
Tools & Screws & Fittings .....	02
Overall installation steps .....	03
Detailed installation steps .....	04-20

# COMPONENTS NAME

Get to know the parts of your bicycle. This will help with assembly, maintenance, and trouble shooting.

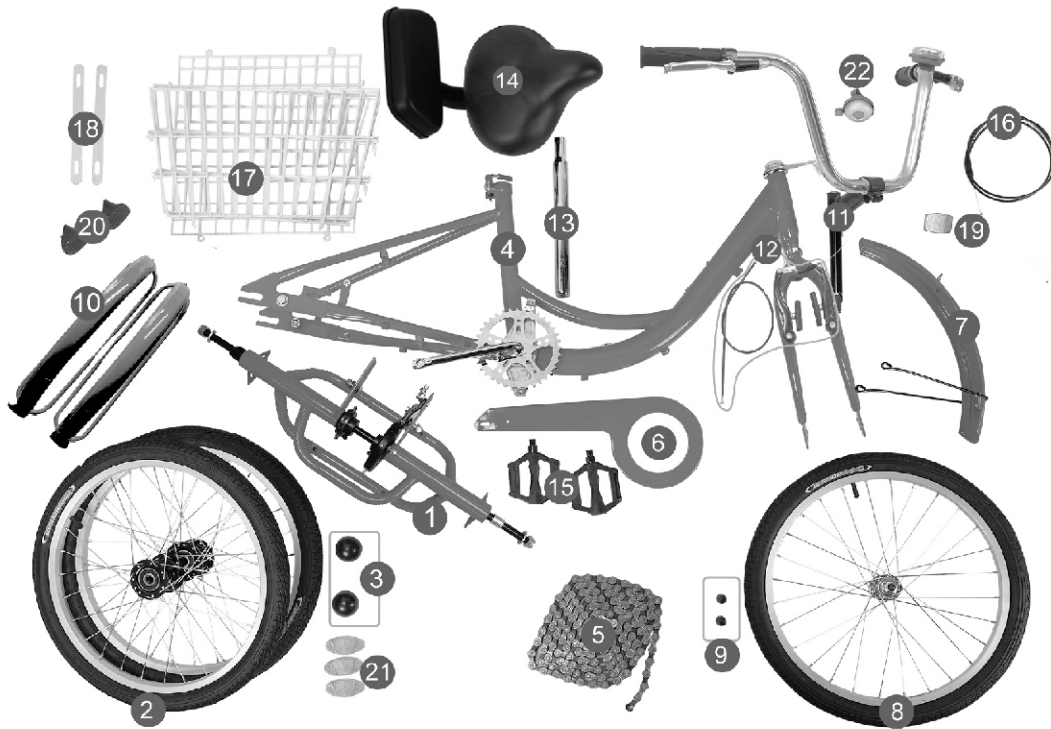



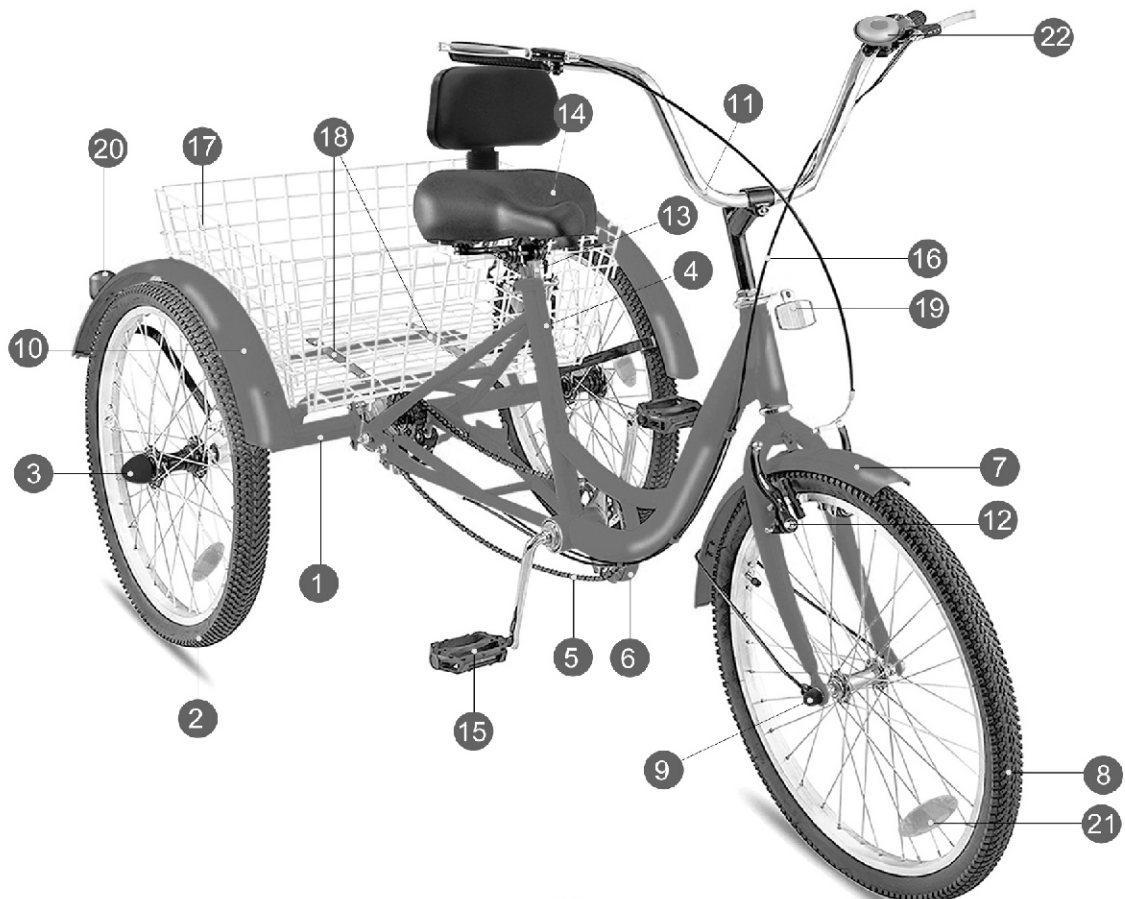

NO.	Part Name
1	Rear Axle
2	Rear Wheel
3	Rear Axle Plug
4	Frame
5	Chain
6	Chain Cover
7	Front Fender
8	Front Wheel
9	Front Axle Plug
10	Rear Fender
11	Handlebar
12	Front Brake
13	Seat Post
14	Saddle
15	Pedal
16	Rear Brake Cable
17	Rear Basket
18	Basket Long Gasket
19	Front Reflector
20	Rear Reflector
21	Spoke Reflector
22	Bell











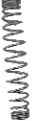
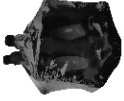

# TOOLS & SCREWS & FITTINGS







## TOOLS

			
<p><b>Multi-Function Screwdriver</b></p>	<p><b>Multi-Function Wrench</b></p>	<p><b>Adjustable Wrench</b> ( Not included in the package, you need to bring your own )</p>	<p><b>Pincer Pliers</b> ( Not included in the package, you need to bring your own )</p>

## Inner box packaging

				
<p>2pcs</p>	<p>8pcs</p>	<p>1pcs</p>	<p>1pay</p>	<p>3pcs</p>

						
<p>2pcs</p>	<p>1pcs</p>	<p>1pcs</p>	<p>1pcs</p>	<p>1pcs</p>	<p>2pcs</p>	<p>1pcs</p>

						
<p>2pcs</p>	<p>2pcs</p>	<p>4pcs</p>	<p>4pcs</p>	<p>8pcs</p>	<p>2pcs</p>	<p>1pcs</p>

**⚠ The chain of the single-speed tricycle is different from the chain of the 7-speed tricycle. Please follow the instructions below. Parts to be prepared: chain, three-piece magic buckle, needle-nosed pliers**

**⚠ Also note that single-speed tricycles do not have rear brakes and shifting, please ignore these two installation steps.**

## Required Parts And Tools



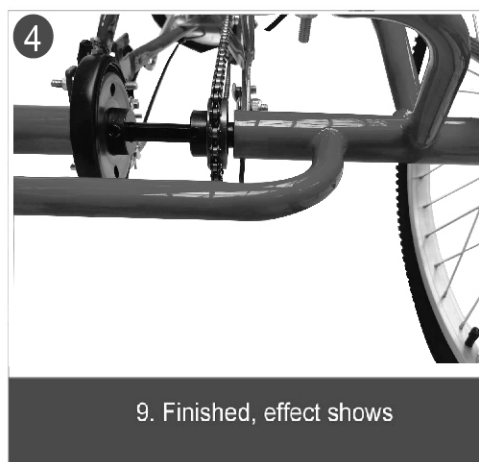
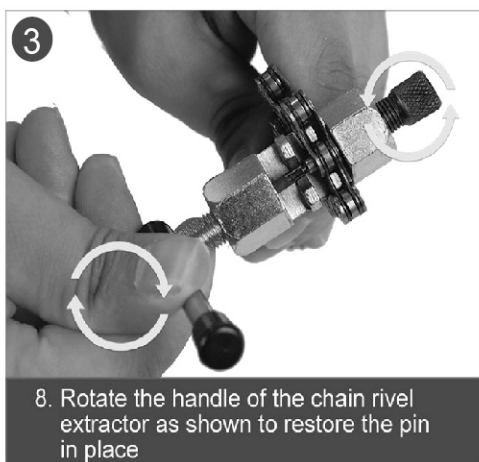
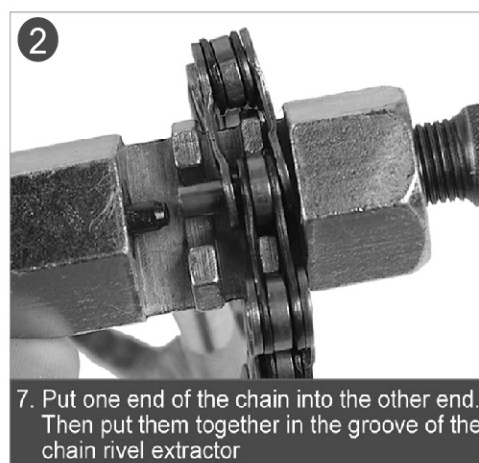
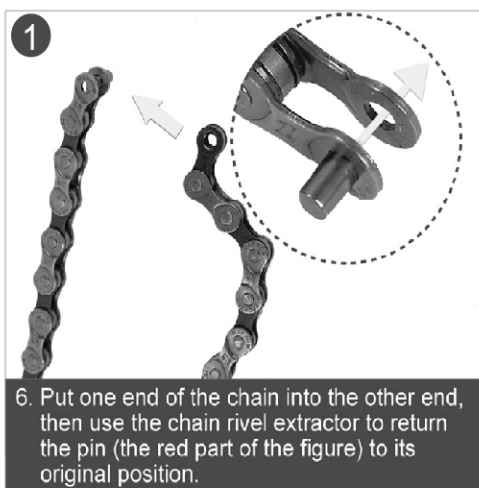

Installed Parts	Chain	Chain Rivel Extractor
	<b>6</b> 	<b>D</b> 

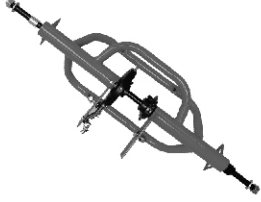

# THE INSTALLATION OF REAR WHEEL

01

## Required Parts And Tools

Installed Parts	Rear Wheel	Rear Axle Plug	Adjustable Wrench
	<b>2</b> 	<b>3</b> 	<b>C</b> 

## Detailed Installation Steps

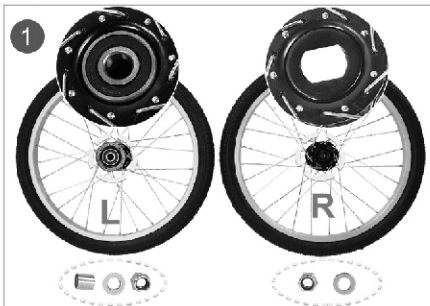

1. Differentiate the left or right wheel according to the shape of the screw hole

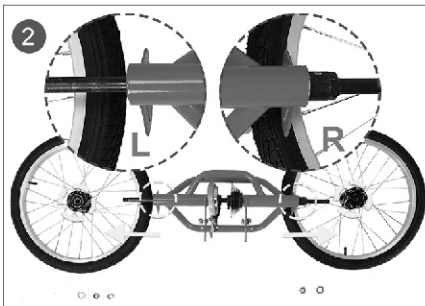

2. Differentiate the left or right of the rear axle according to the shape of the two ends of the rear axle



3. First, assemble the right wheel. Insert the bolt of the right axle into the screw hole of the right wheel.

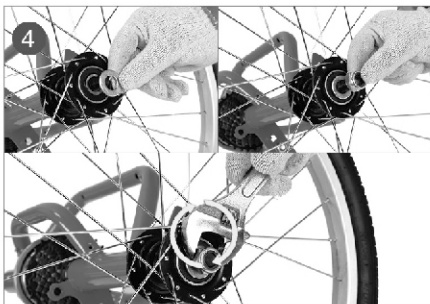

4. Put the gasket first, then the nut, and finally tighten with a wrench



5. Put the metal tube on the left axis before installing the left wheel



6. The same operation as installing the right wheel

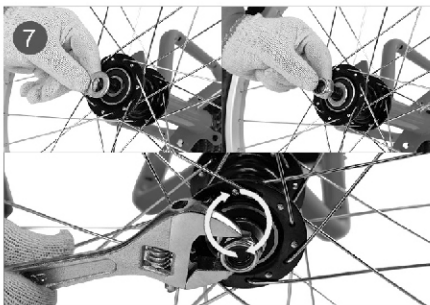

7. The same operation as installing the right wheel

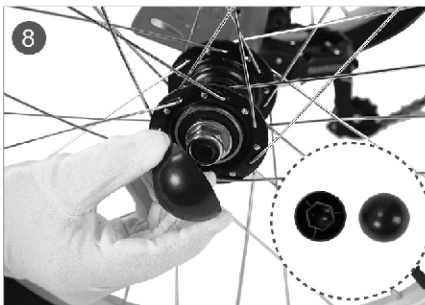



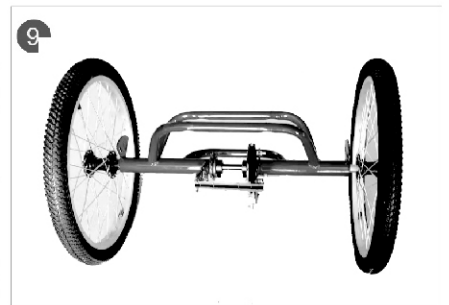

8. Cover the rear axle plug

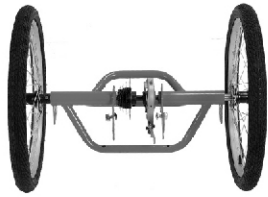

9. Finished, the effect shows

## Required Parts And Tools

Installed Parts	Frame	Multi-Function Wrench	Adjustable Wrench
	<b>4</b> 	<b>B</b> 	<b>C</b> 

## Detailed Installation Steps

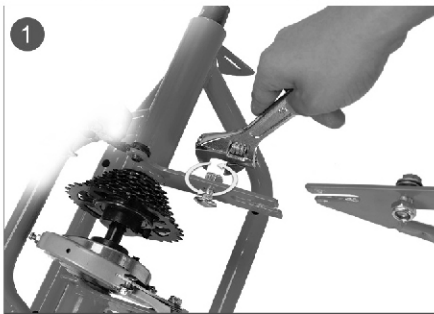

**1.** Loosen the screws before installation (the screws required for this step are fixed on the rear axle and the frame)

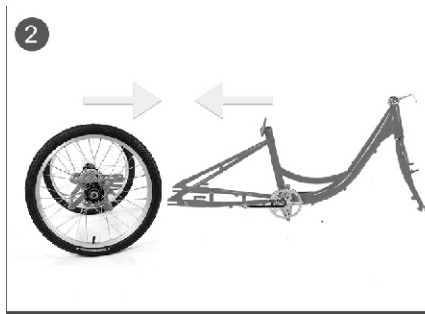

**2.** Connect the rear axle and frame, as shown

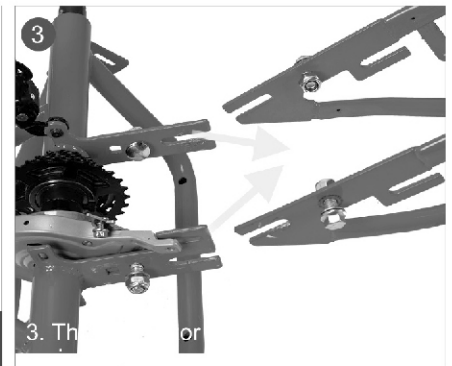

**3.** The rear axle is aligned with the frame

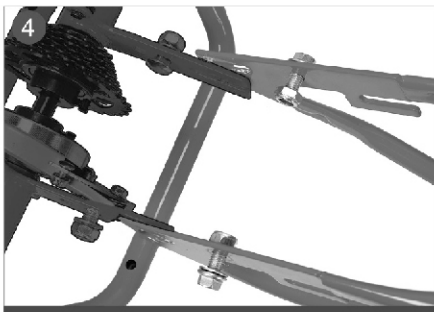

**4.** Clearer display



**5.** Use both multi-function wrench and adjustable wrench

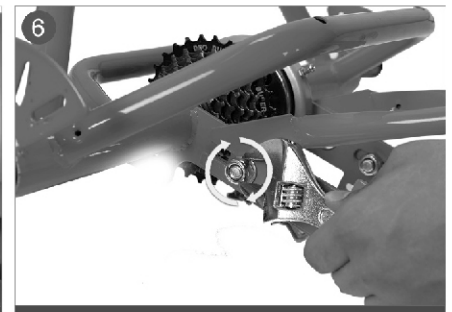

**6.** Tighten the first screw

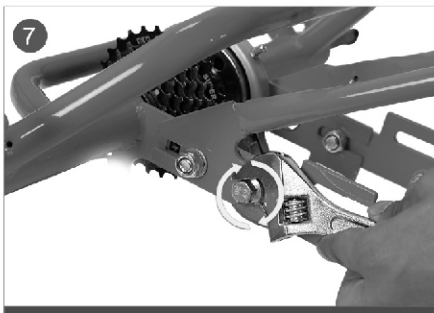

**7.** Tighten the second screw

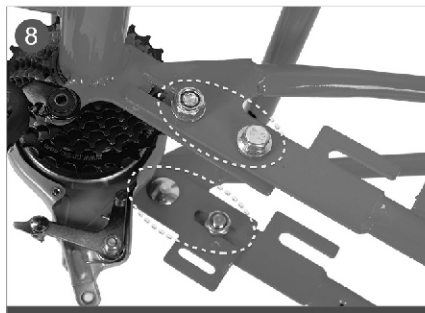



**8.** Four screws are tightened



**9.** Finished, effect shows

## Required Parts And Tools

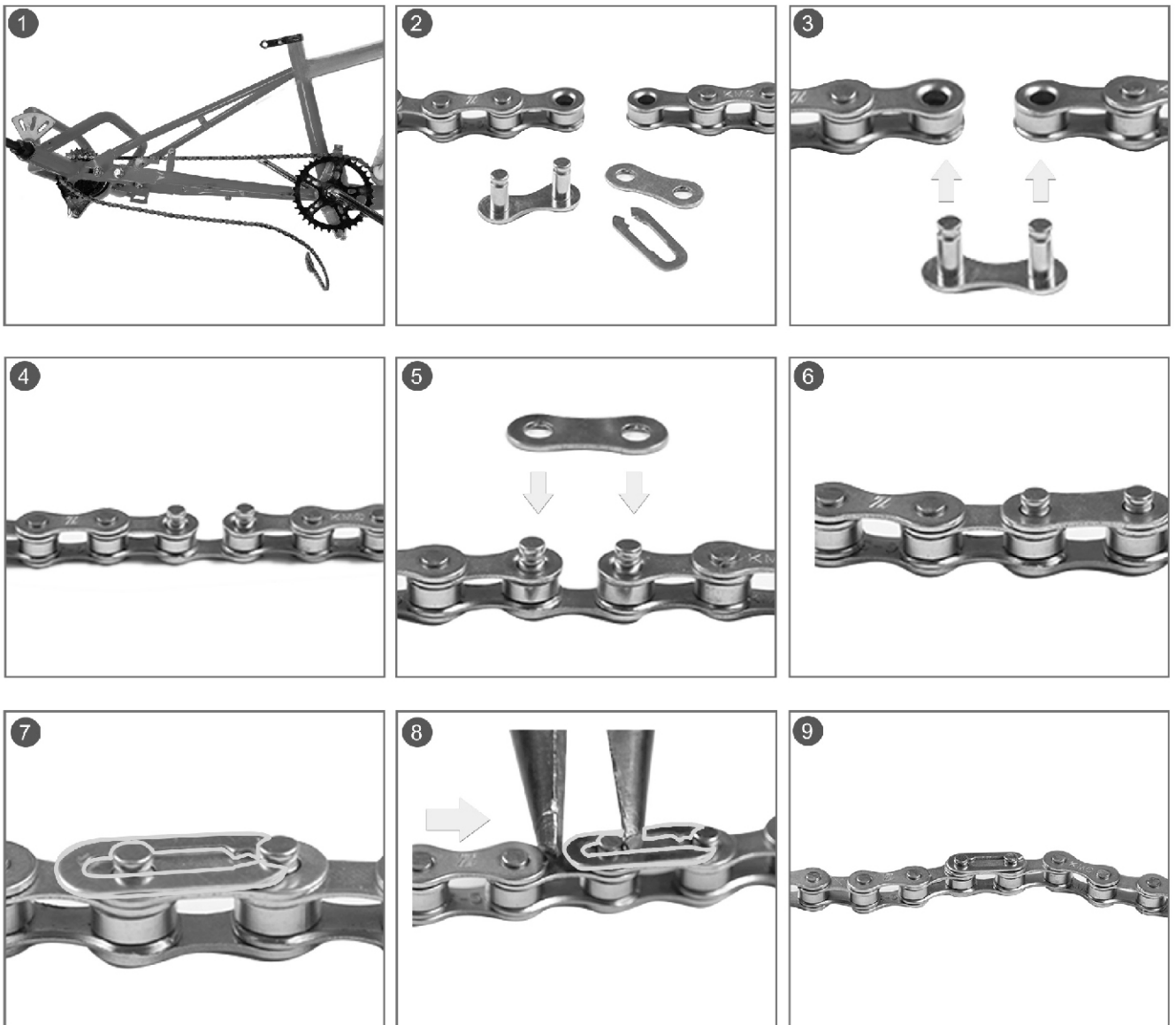

Installed Parts	Chain	Chain magic buckle
	<b>5</b> 	

## Detailed Installation Steps



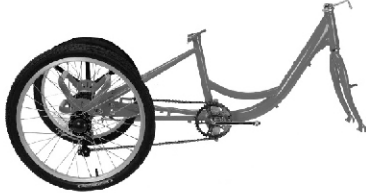

## Required Parts And Tools

Installed Parts	Chain Cover	Multi-Function Screwdriver
	<b>6</b> 	<b>A</b> 

## Detailed Installation Steps

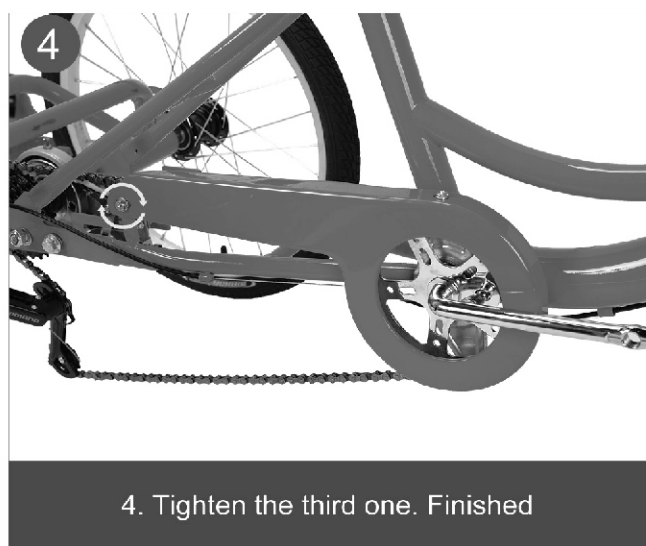
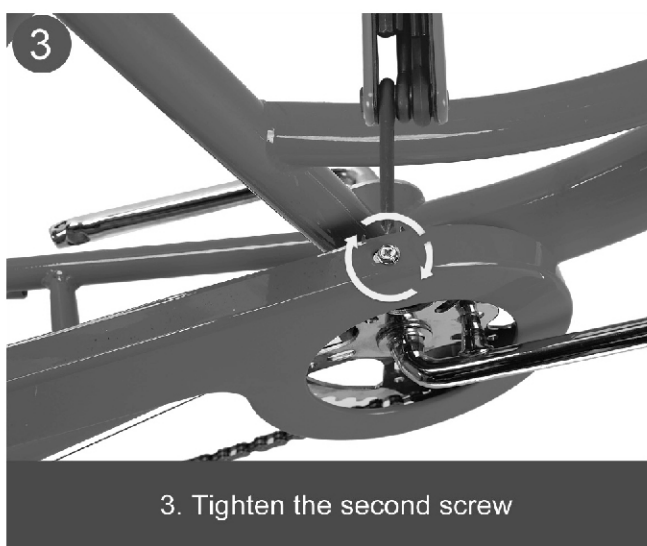
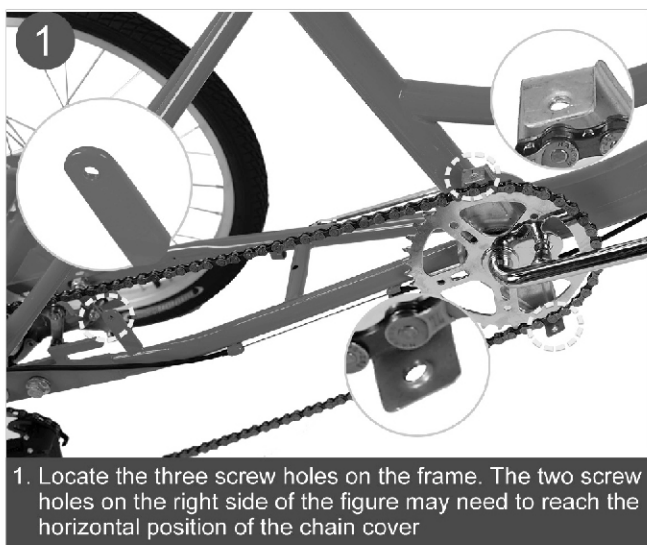

# THE INSTALLATION OF FRONT FENDER

05

## Required Parts And Tools

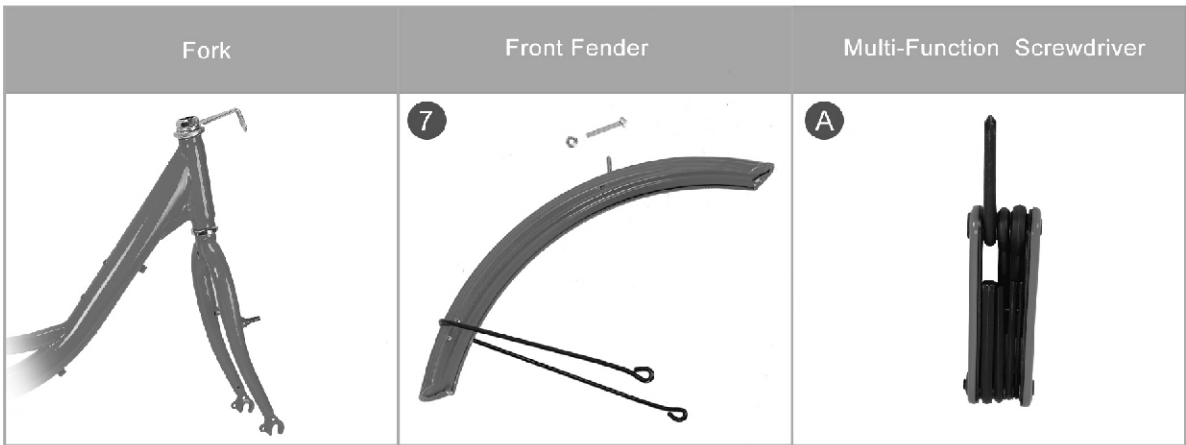

## Detailed Installation Steps

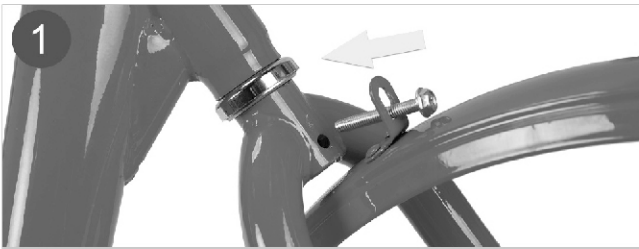

1. The screw hole on the vehicle is aligned with the screw hole on the fork. Note: This step requires.



2. Tighten the three screws with a Phillips screwdriver

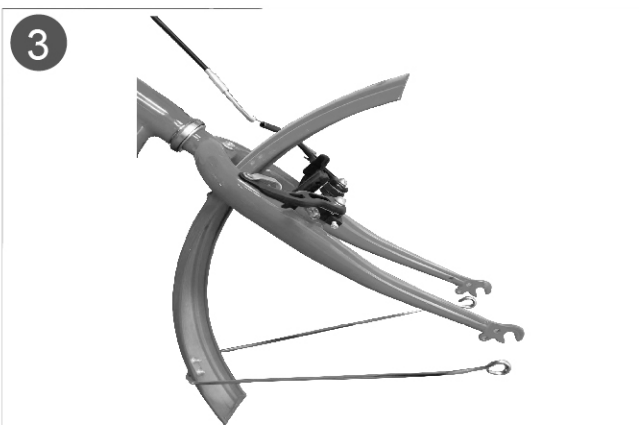



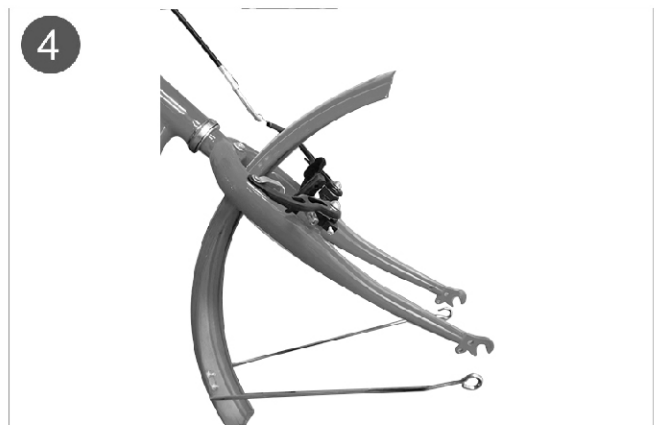

3. Finished, partial effects show



4. Finished, the overall effect shows

## Required Parts And Tools

Fork	Front Wheel	Front Axle Plug	Adjustable Wrench
			

## Detailed Installation Steps



1. Put the front wheel into the forks.



2. Let the screw hole on the front fork catches the bolt.



3. The hook is on the inner mud board and the middle nut is on the outside



4. Special Note: There is a hook on the washer. Let it hook into the hole in the front fork for better fixing.



5. Tighten the screws with a wrench.



6. Make sure there is no friction between the tire and the fender



7. Cover the front axle plug.







8. Finished, the partial effect display.



9. Finished, the overall effect display

## Detailed Installation Steps

Bell	Front & Rear Reflector	Wheel Reflector	Multi-Function Screwdriver
22 	19 20 	21 	A 

## Detailed Installation Steps



1. The yellow dotted line on the right handlebar is the location where the bell is installed.



2. Tighten with a Phillips screwdriver



3. Position for installing the front reflector



4. Tighten the screw

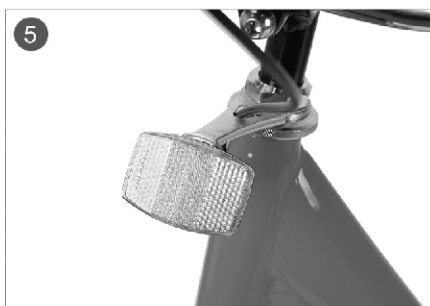

5. Finished, the effect shows



6. Position for installing the rear reflector



7. Two rear reflectors mounted on the left and right fenders

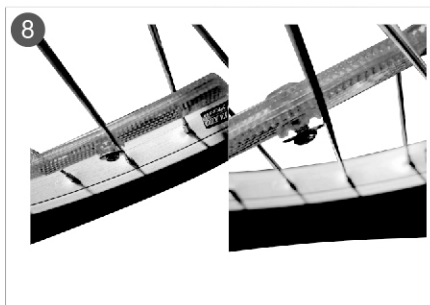

8. Position for installing the spoke reflector

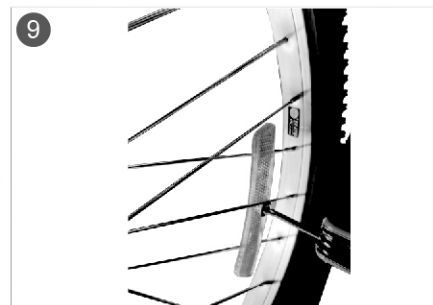

9. Three spoke reflectors mounted on the spokes of two rear wheels and one front wheel

## Required Parts And Tools

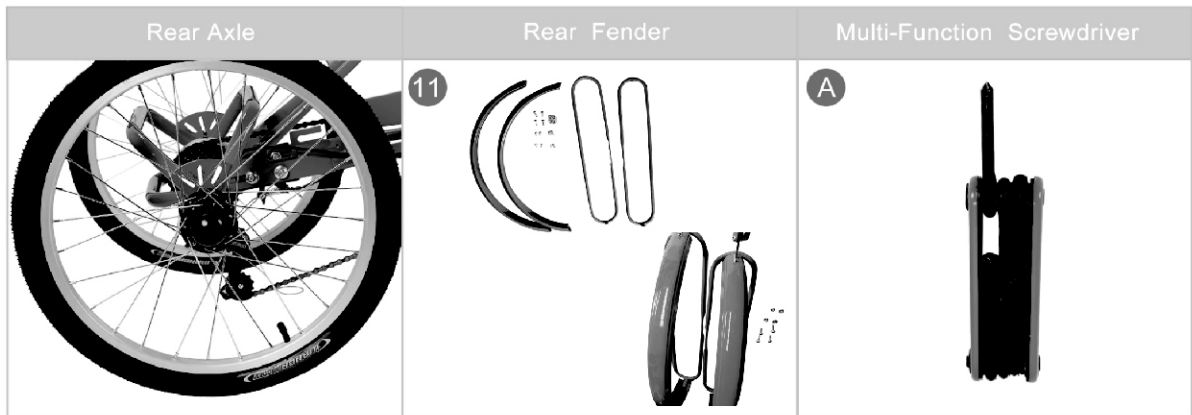

## Detailed Installation Steps

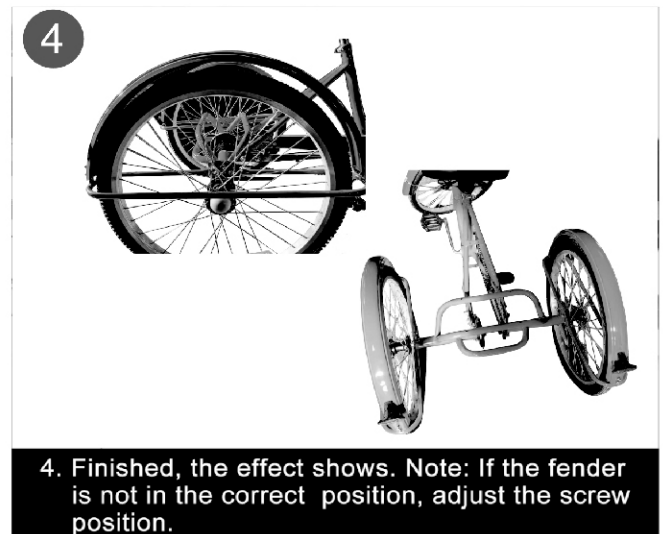
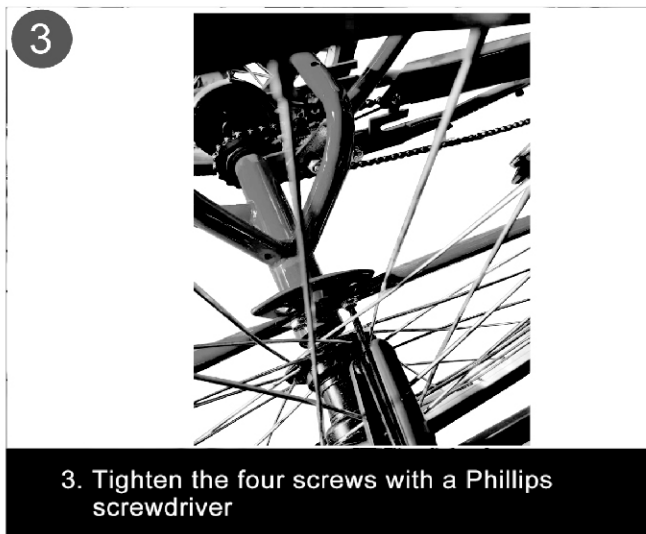

## Required Parts And Tools

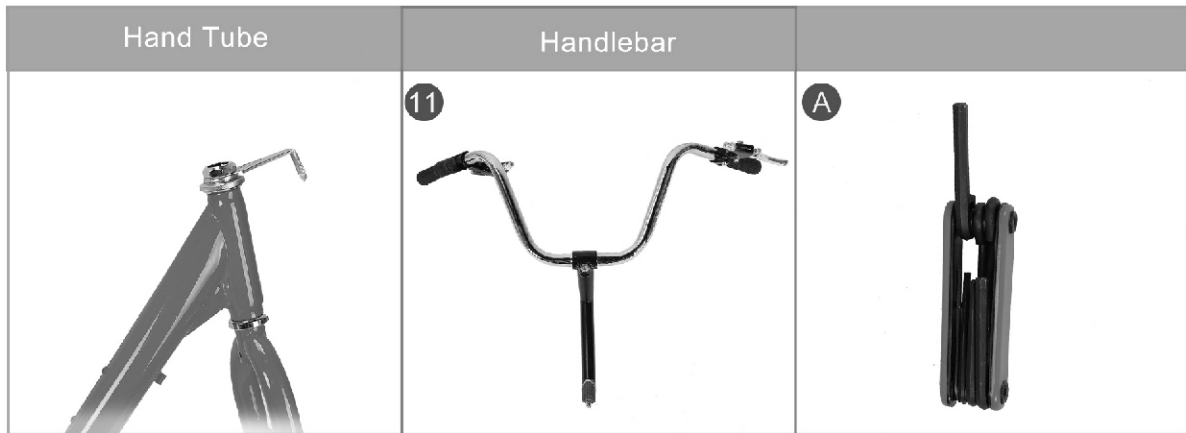

## Detailed Installation Steps

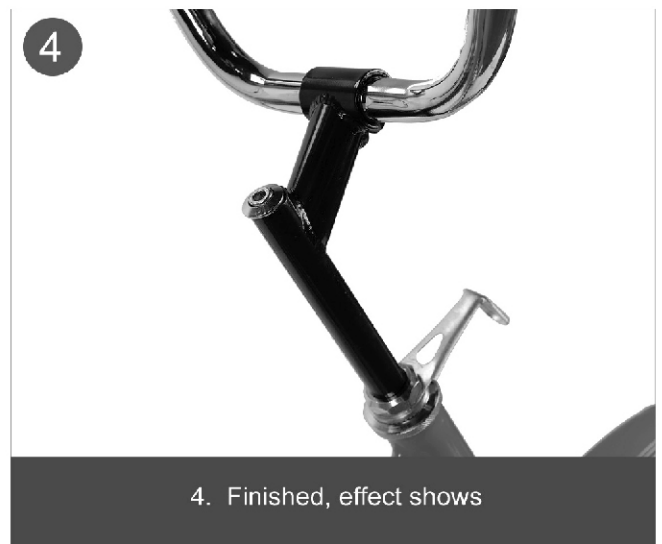
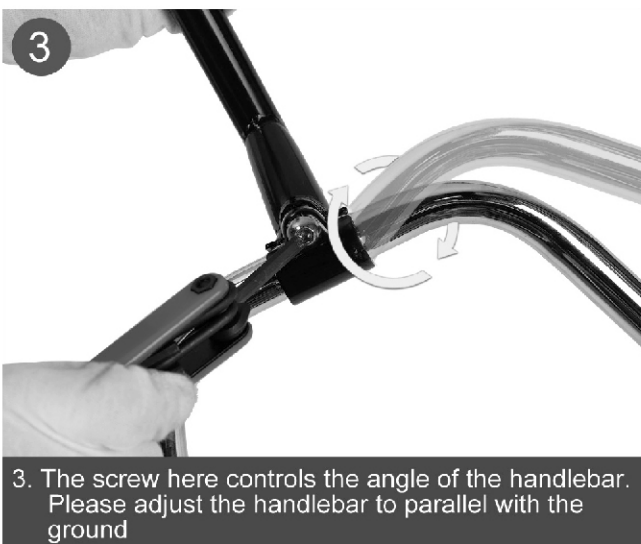
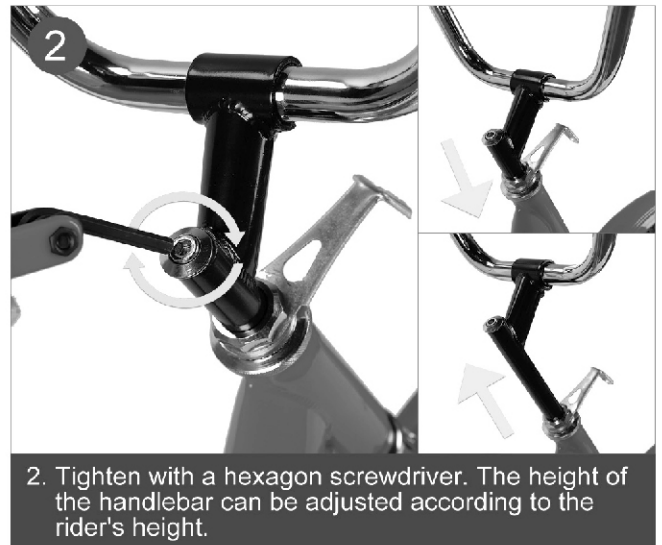
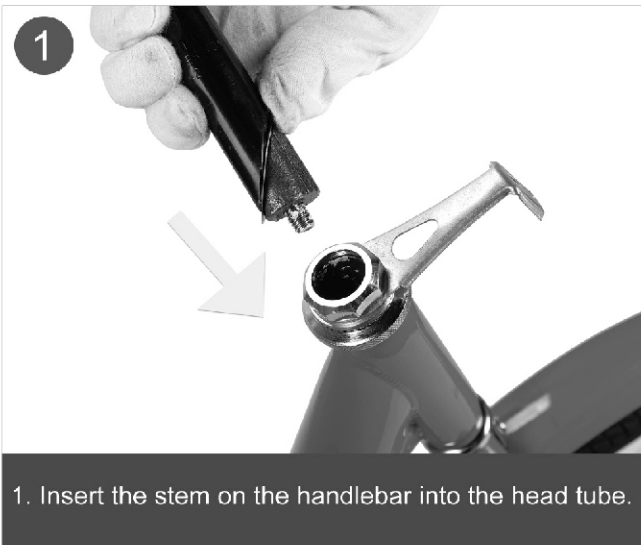

## Required Parts And Tools

Seat Tube	Seat Post	Saddle	Multi-Function Wrench
	<p>14</p> 	<p>15</p> 	<p>B</p> 

## Detailed Installation Steps

- 

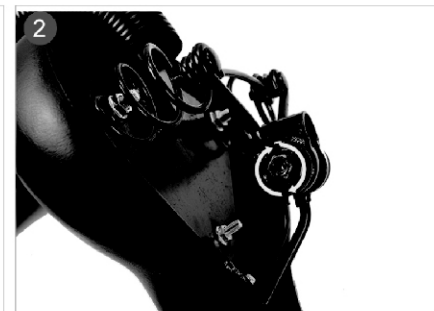
1. The hole-position on the saddle used to insert the seat post.
- 

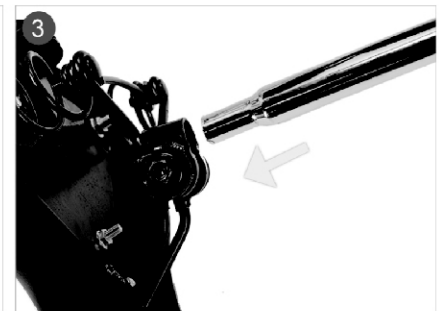
2. Loosen the screw on the hole with a wrench.
- 

3. Insert the thin end of the seat post into the hole-position on the saddle.
- 

4. Tighten the nut with a wrench.
- 

5. Loosen the seat post clamp.
- 

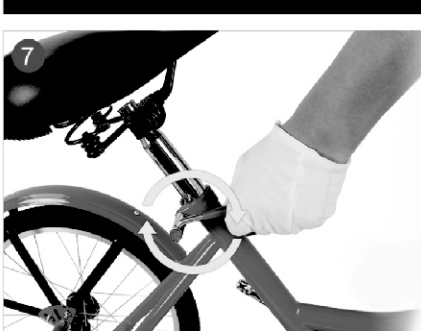
6. Insert the other end of the seat post.
- 

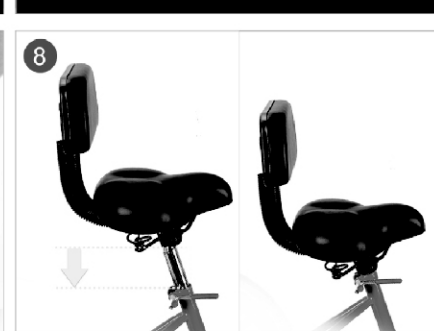
7. Tighten the seat post clamp.
- 

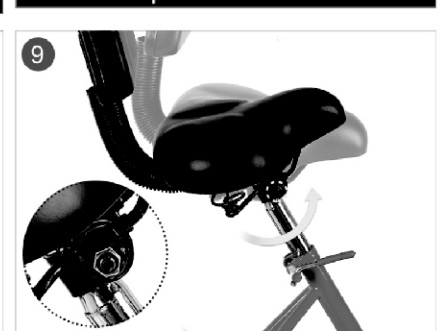
8. Adjust the height of the saddle according to the height of the rider.
- 

9. Adjust the angle of the saddle by the green screw in the figure.

## Required Parts And Tools

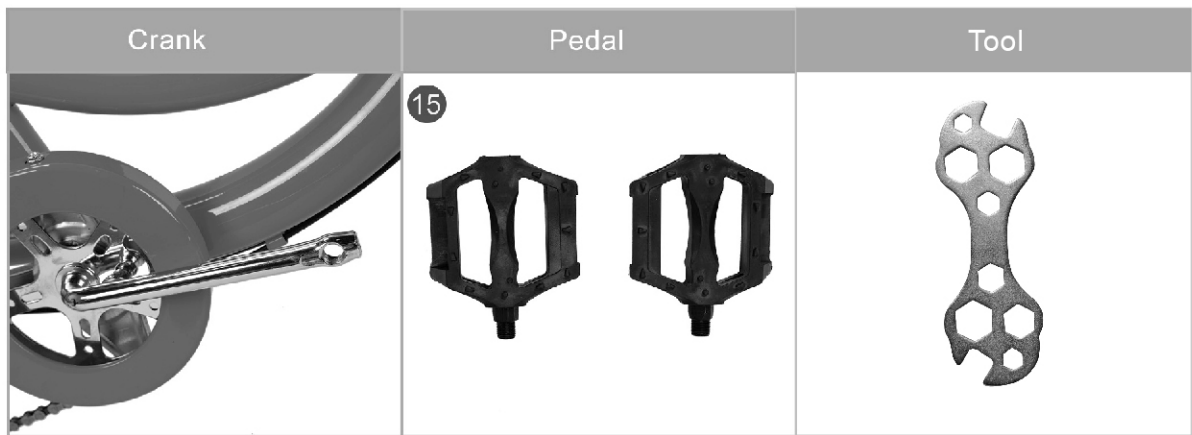

## Detailed Installation Steps

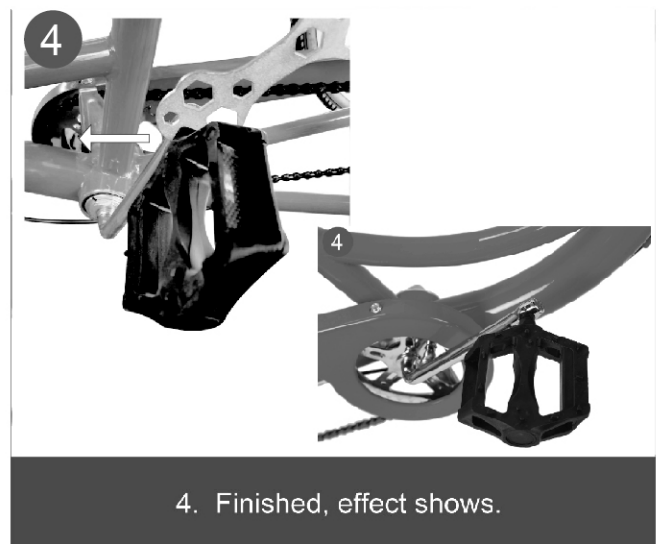
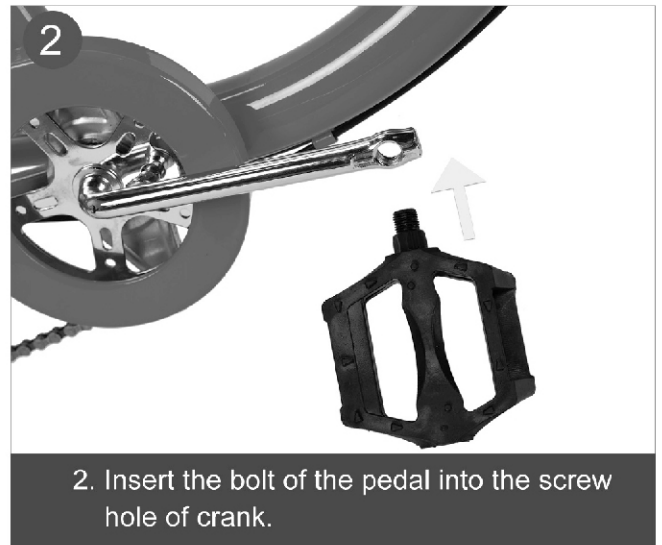
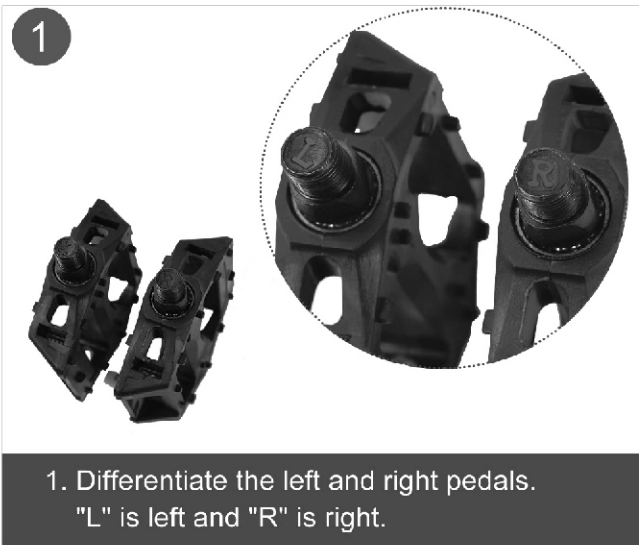



## Required Parts And Tools

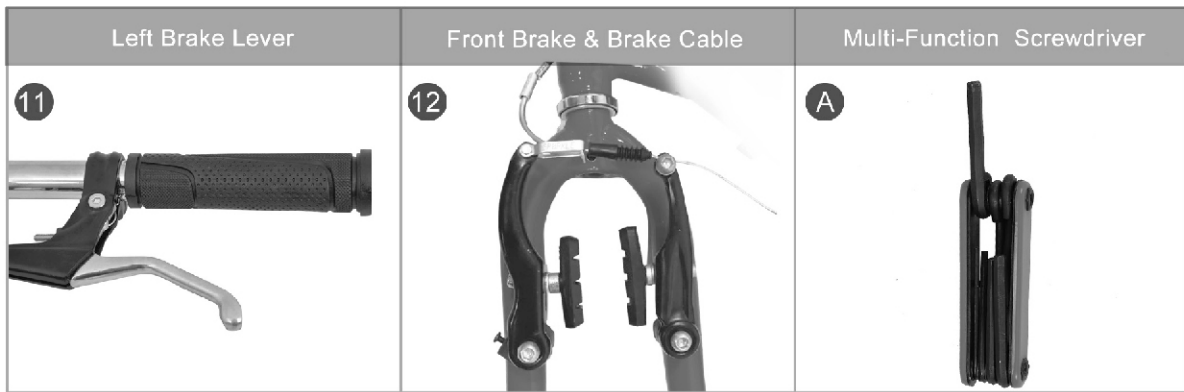

## Detailed Installation Steps

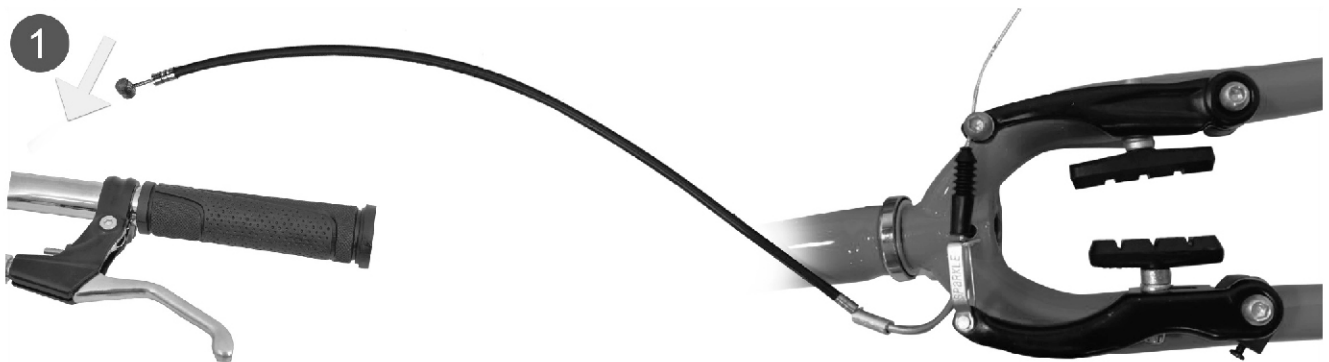

1. Connect the front brake cable to the right brake lever.

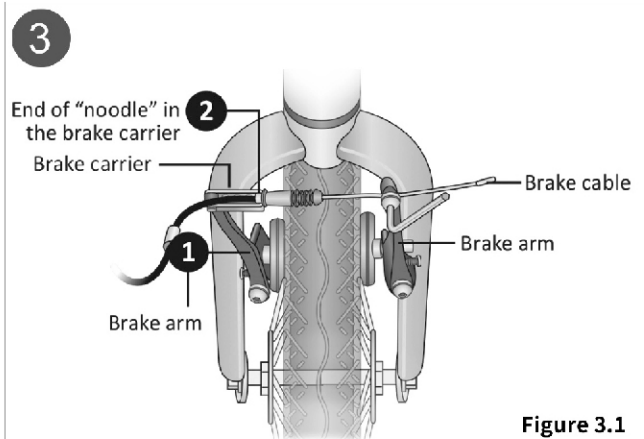
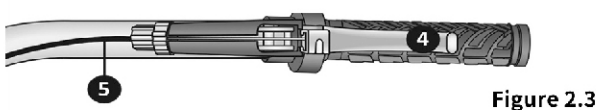
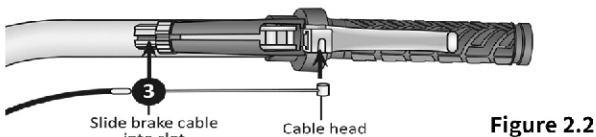
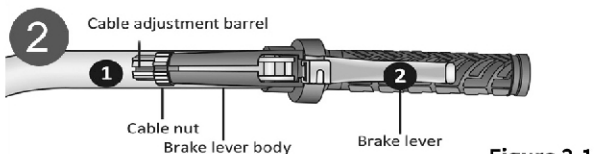

### Attaching the Brake Cable to the Brake Lever

If the brake cable is not attached to the brake lever follow these steps:

- ① Rotate the cable adjustment barrel and cable nut until the slots are aligned with the slot on the brake lever body. Figure 2.1
- ② Press the brake lever towards the grip.
- ③ Slide the brake cable through the slots and place the cable head into the brake lever. Figure 2.2
- ④ Release the brake lever. Figure 2.3
- ⑤ Lightly pull on the cable, and rotate the cable nut and cable barrel so they are no longer aligned

### Attaching the Brake Cable to the Brake Lever

- ① Squeeze the two brake arms together until the brake pads touch the wheel rim. Figure 3.1
- ② With your other hand, pull on the brake cable and insert the end of the "noodle" into the brake carrier.

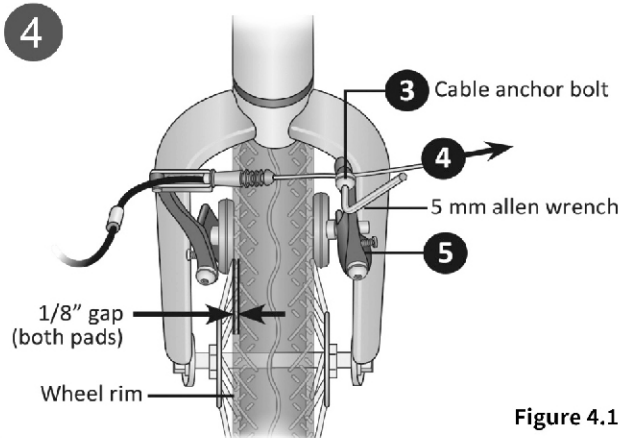

Figure 4.1

### Adjusting the Brake Pads

- ① Check the brake cable is seated in the brake lever. Using a 5 mm allen wrench loosen the cable anchor bolt enough so the brake cable can move freely. Figure 4.1
- ② Pull the brake cable through the cable anchor so the left brake arm moves towards the rim and there is approximately a 1/8" (3 mm) gap between the brake pad and rim.
- ③ Move the right brake arm towards the rim until there is approximately a 1/8" (3 mm) gap between the brake pad and rim.
- ④ Using the 5 mm allen wrench, firmly tighten the cable anchor bolt completely.

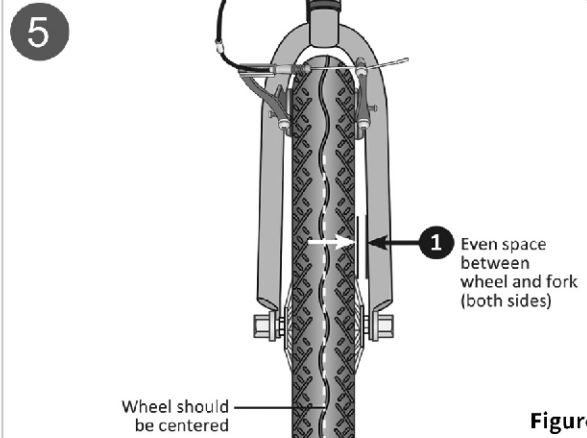

Figure 5.1

### Center the Brake Pads

Rotate the wheel and look straight down at the gap between the rim, brake pads, and fork. If you find the gap between these are uneven it indicates the wheel, the brake pads, or both are not centered.

- ① If you see the gap between the fork and wheel is uneven loosen the axle nuts and adjust the wheel until centered. Figure 5.1

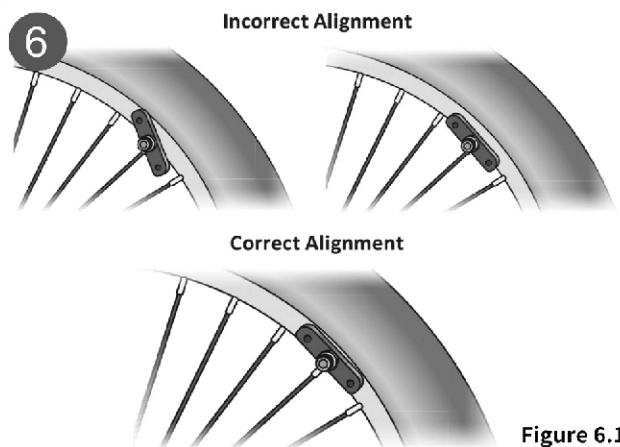

Figure 6.1

### Adjust the Brake Pad Alignment

Check that all brake pads are aligned correctly. If not, use a 5 mm allen wrench and loosen the bolt enough so you can reposition the pad. Position the pad so it is evenly centered on the rim. Retighten the bolt after positioning the pad correctly. Figure 6.1

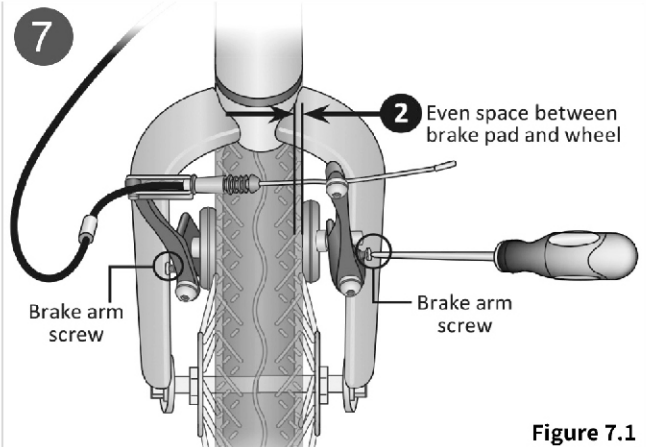

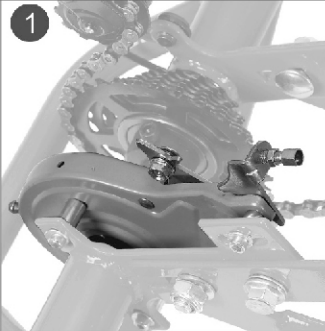



Figure 7.1

### If the gap between the brake pad and wheel is uneven, adjust the position of the brake pad.

- ① Using a phillips head screwdriver, adjust the brake arm screws on either side of the brake arm. Note: Turning the screw clockwise moves the pad away from the rim. Turning the screw counterclockwise moves the pad towards the rim. Figure 7.1
- ② Start with the side where the pad is closest to the rim or is not moving properly. Turn the screw to move the pad towards or away from the rim.
- ③ Adjustments to these screws should be made in small increments, one-quarter to one-half turn then checked by activating the brake lever three to four times after each adjustment. If you continue to adjust the screw until you have noticeable movement you will run out of adjustment.

## Required Parts And Tools

Rear Brake Cable	Right Brake Lever	Rear Brake	Multi-Function Wrench
16 	11 	1 	B 

## Detailed Installation Steps

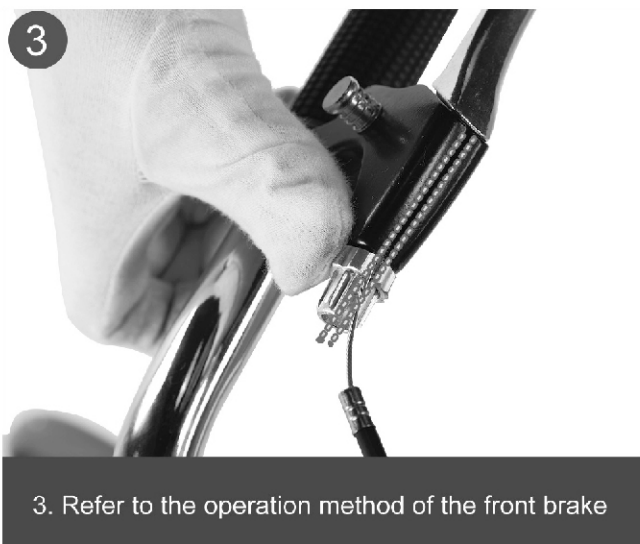
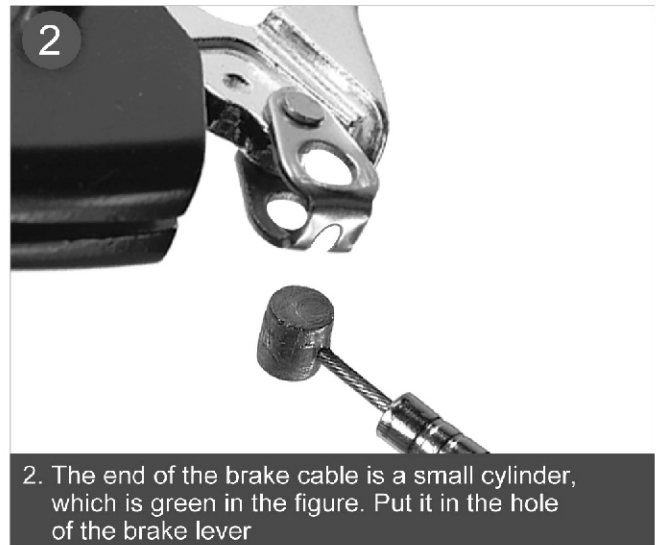
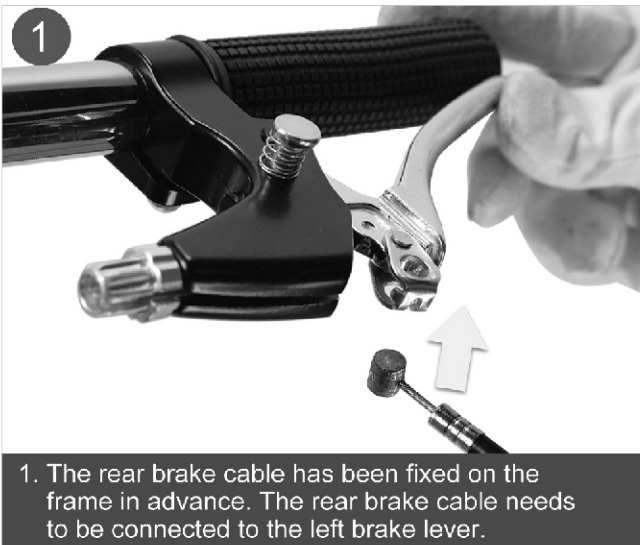

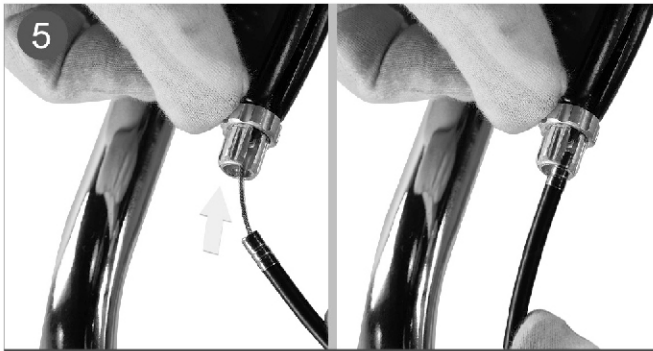

5. Fix the brake cable housing into the brake lever.

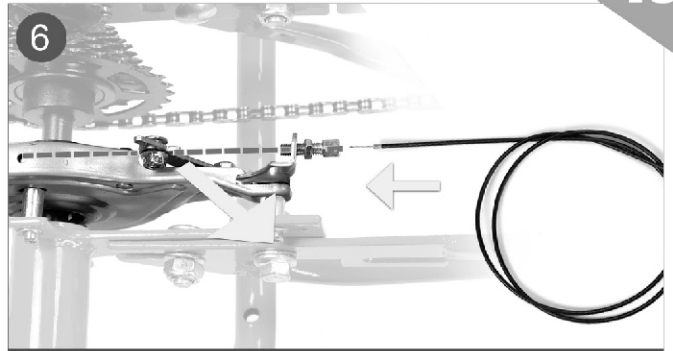

6. The brake cable route.

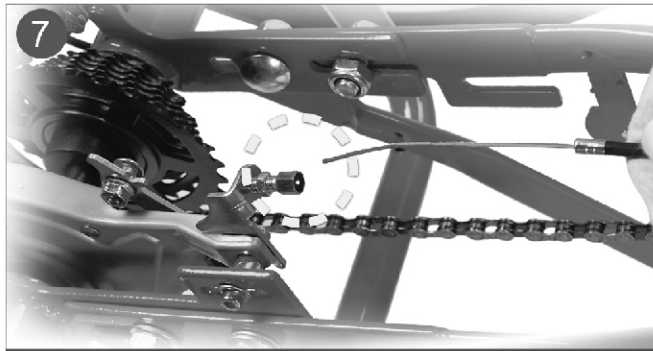

7. Insert the brake cable into the green screw hole.



8. Put on the brake spring.

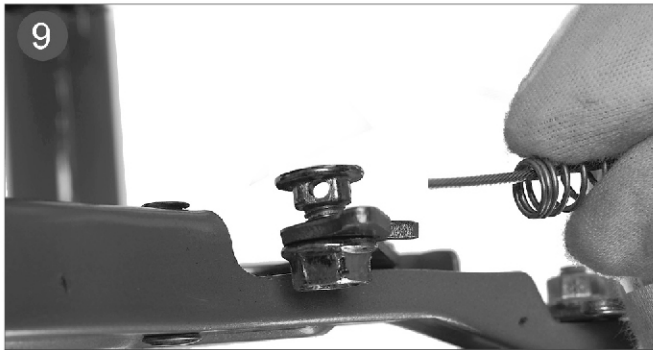

9. Through the hole of the bolt



10. Clear shows



11. Tighten the screw



12. Finished, effect shows

# THE INSTALLATION OF BASKET

14

## Required Parts And Tools

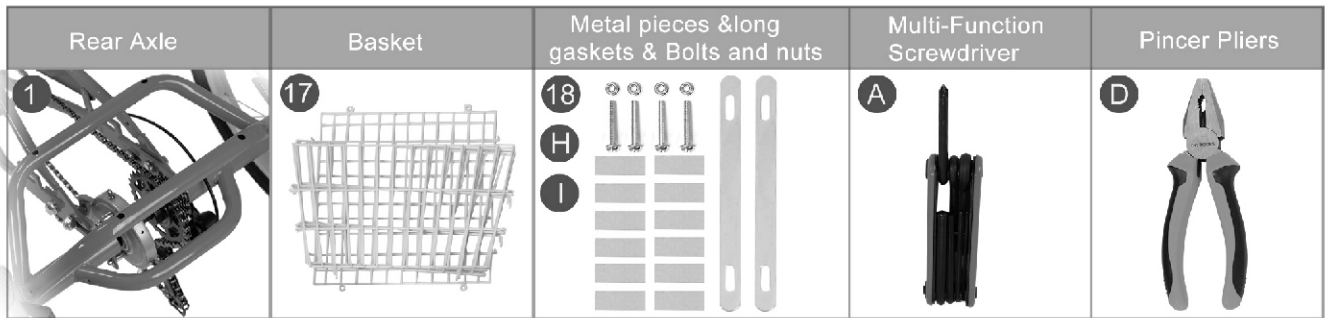

## Detailed Installation Steps

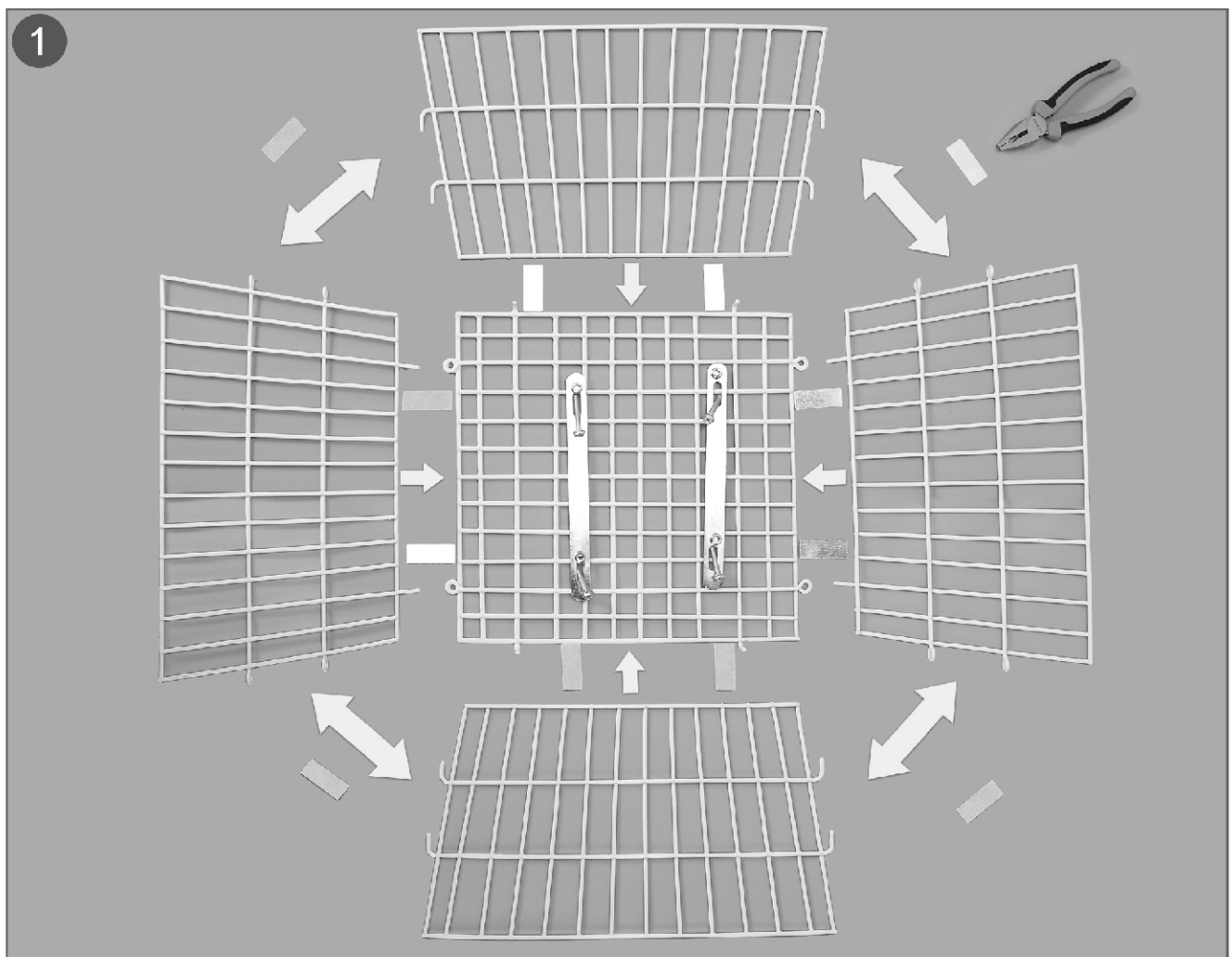

1. All the required parts are in this picture. The basket is made up of 5 separate parts. Connect them in the direction of the arrow.

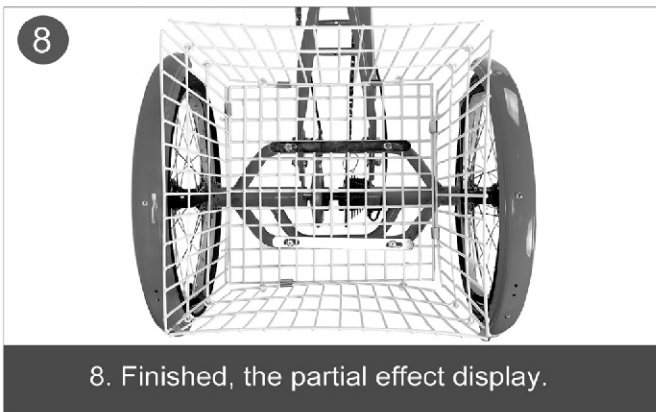
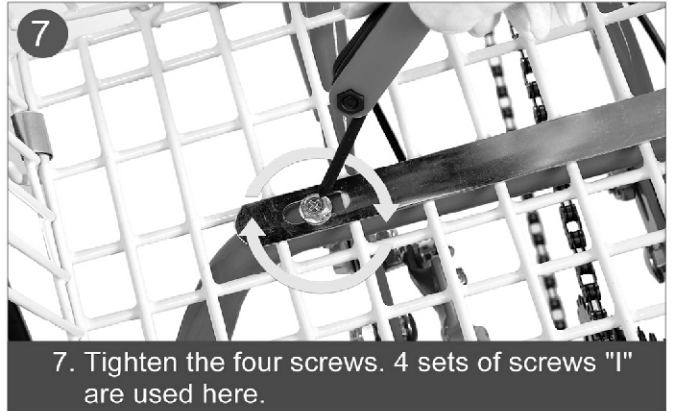
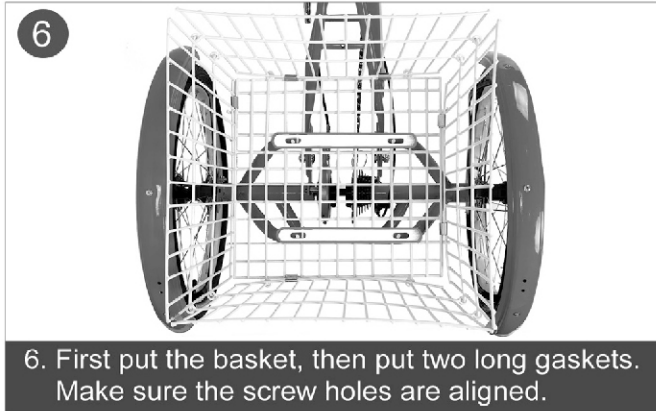
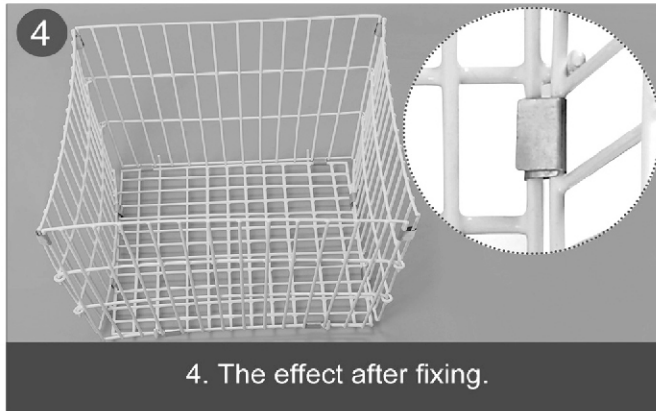
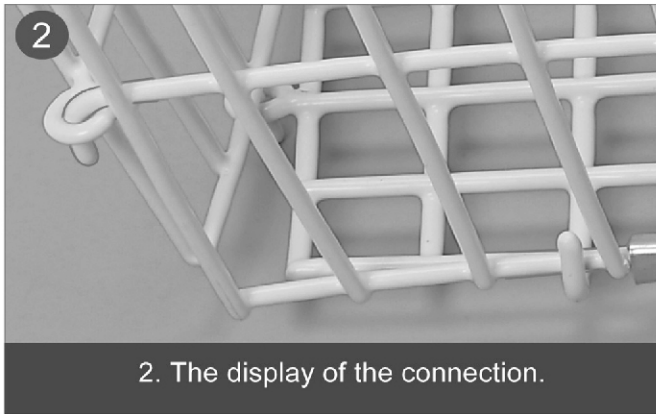

# Fold your tricycle to save up 40% space!

