

L C D
D I G I T A L R E A D O U T S

Operation Manual

DRO for 2 axes

DRO for 3 axes

Contents

Chapter 1	Brief Introduction	1
1.1	Interface	6
1.2	Coordinate System	7
Chapter 2	BASIC OPERATION	8
2.1	Power on	9
2.2	Zeroing	9
2.3	Preset Data to designed axis	9
2.4	Toggle display unit between mm and inch	10
2.5	Mid-point Calculation	10
2.6	Absolute / Incremental / 500 groups SDM	11
2.7	Clear All SDM Datum	12
2.8	Lathe Function	12
2.9	Filter display value	13
2.10	Close the screen	13
Chapter3	500 groups SDM coordinate	14
3.1	Zeroing at the Current Point	15
3.2	Preset datum of SDM Coordinate	16
Chapter 4	SPECIAL FUNCTIONS	18
4.1	Bolt Hole Circle	19
4.2	Bolt Hole Line	21
4.3	Bolt Hole Grid	23
4.4	ARC Processing	24
4.5	Slope Processing	27
Chapter 6	CALCULATOR	29
Chapter 7	INITIAL SYSTEM	31
7.1	Enter/Exit Initial System Settings	31
7.2	System Parameter	31
7.3	Setting the Resolution of scal	31
7.4	Setting Direction for Counter	32
7.5	Setting Linear Compensation	32
7.5.1	Manually compensate	32

7.5.2	Automatic compensation	33
7.6	Setting Section Compensation.....	34
7.7	Linear Scale and Rotary Encoder	35
7.8	R/D Display Mode.....	36
7.9	RS-232.....	36
7.10	Other Setting.....	36
Chapter 8	TROUBLE SHOOTING.....	38

Chapter 1 Brief Introduction

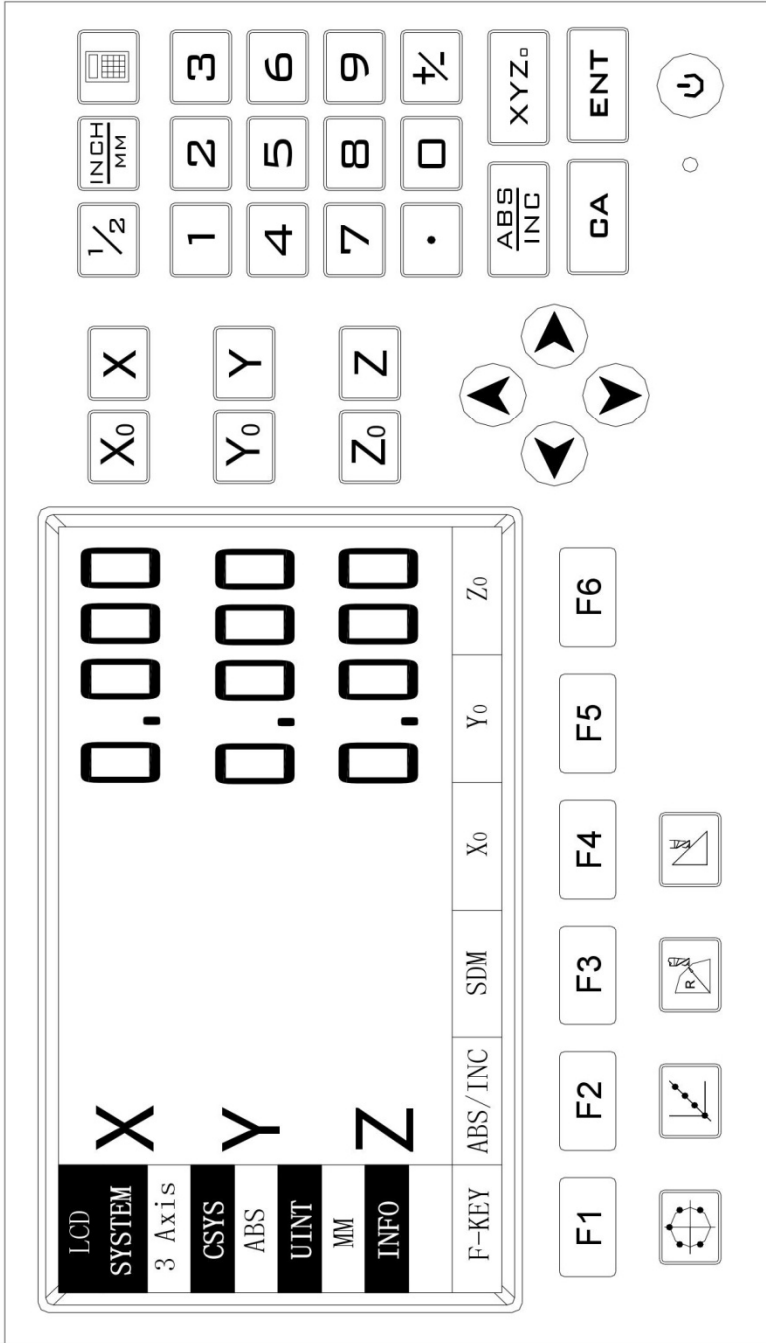

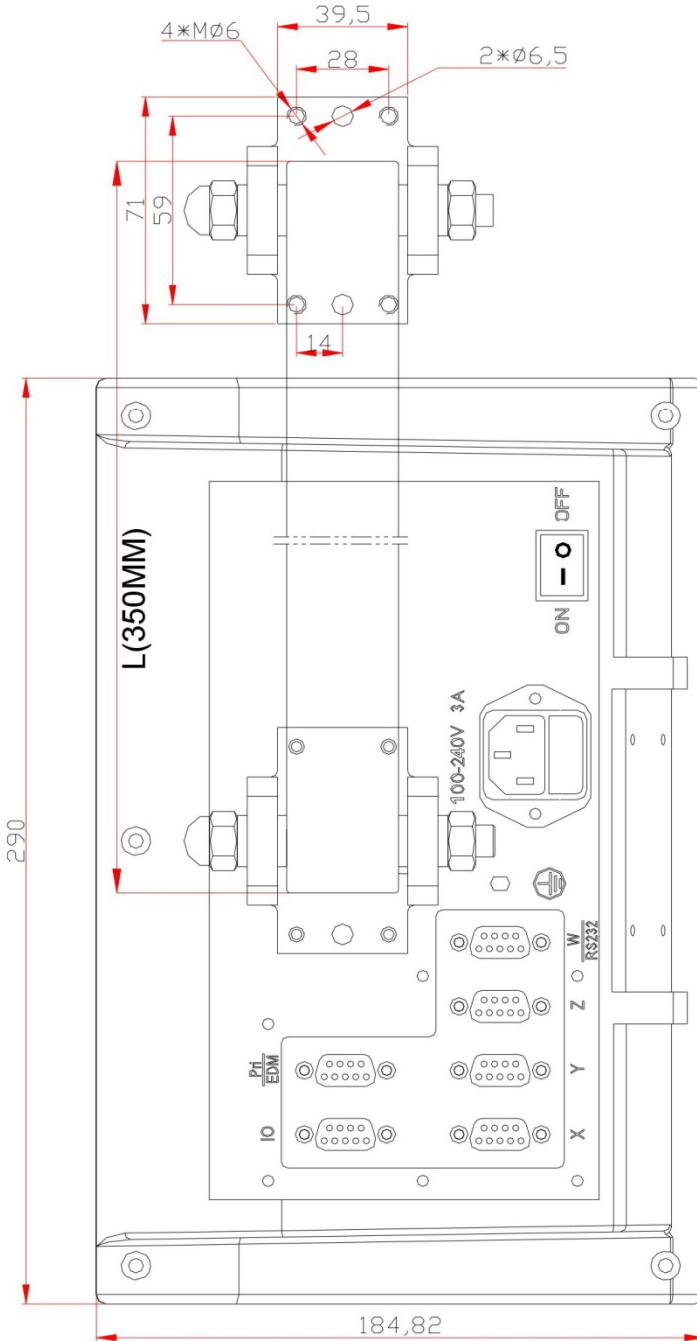



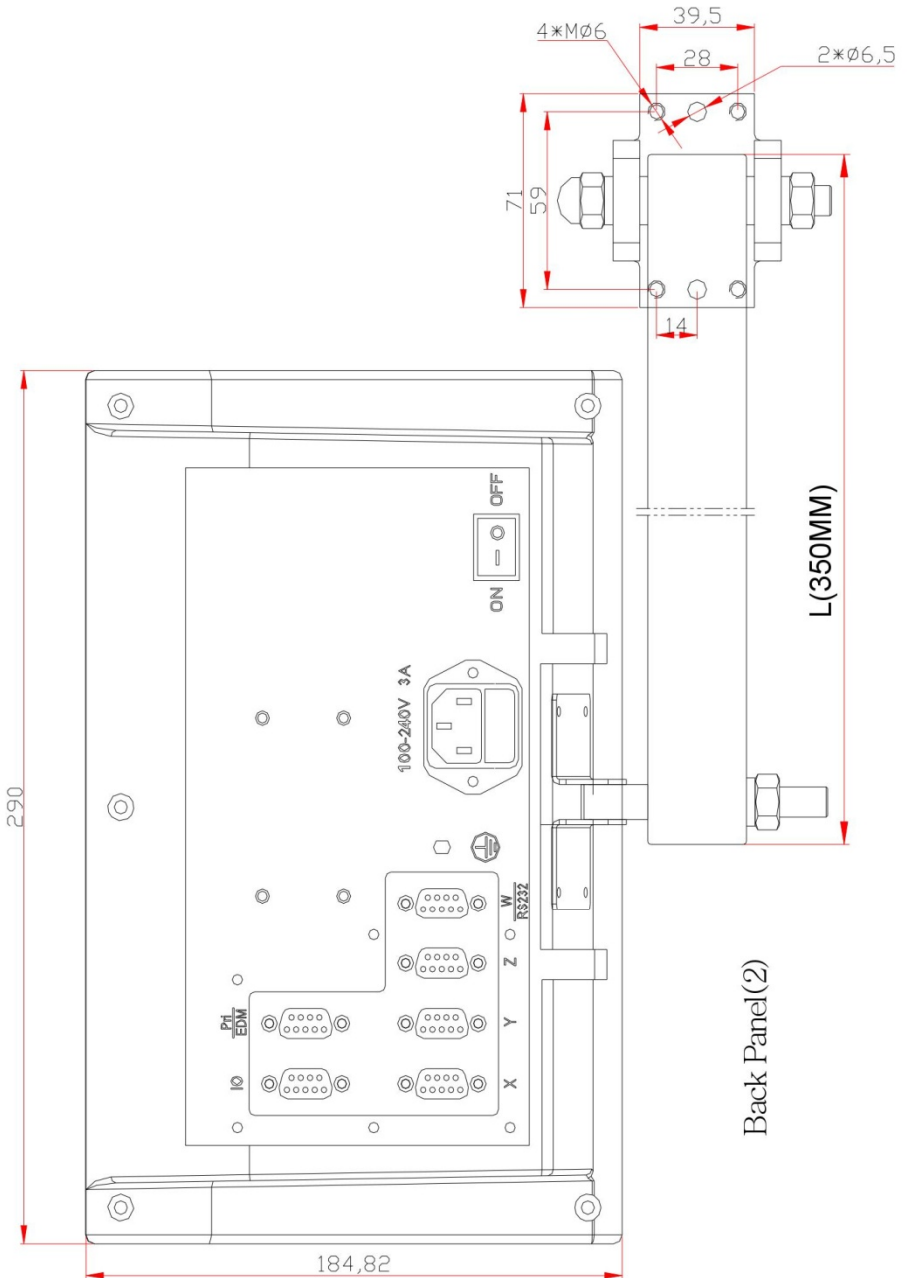















Back Panel(1)



Description of Key Function

KEY MARK	FUNCTION
	Zero selected axis.
	Clear all axes
	Select axis to operate.
	Inch/Metric Switch
	Center Finding
	ABS/IINC Switch
	Numeric Key
	Decimal Point
	+/- Sign
	Enter
	Clearing
	Calculator
	Function selection key
	Process holes displayed equally on a circle.
	Process holes displayed equally on a line.
	Simple R cutting function
	Process a slope.
	Stroll up or down to select.
	LCD Screen switch key

1.1 Interface

A Linear Scale Interface

1) 9PD Connector 1

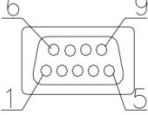

PIN	NAME
1	+5V
2	0V
3	A
4	B
5-9	NC

2) 9PD Connector 2

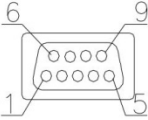

PIN	NAME
1	NC
2	0V
3-5	NC
6	A
7	VCC
8	B
9	NC

3) 15PD Connector

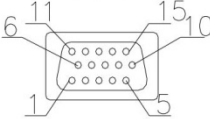

PIN	NAME
1	+5V
2	0V
3	A
4	B
5-15	NC

B RS232 Interface

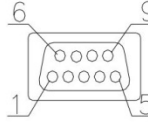

PIN	NAME
1	NC
2	TXD
3	RXD
4	NC
5	GND

9PD signal interface, please consult the agent.

1.2 Coordinate System

DRO is an instrument which can measure position of work piece when processing. Coordinate system must be definite first for more efficiency and accuracy.

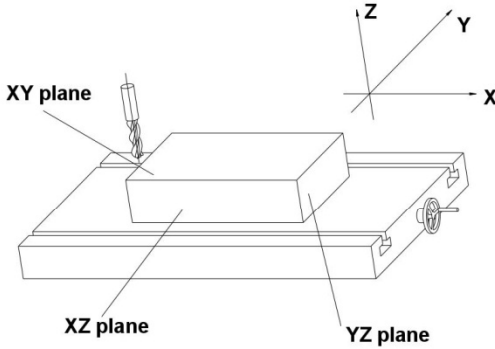

In horizontal plane, the X axis is parallel with the operator; Y axis is perpendicular to X axis. Z-axis is perpendicular to horizontal plane. Positive direction of axis is set as the figure. It also can be changed as customer.

The value of one point position is the distance relative to the origin of coordinate.

For a work-piece as Figure A, the value of each point position is as the Figure B when point O is the origin of coordinate.

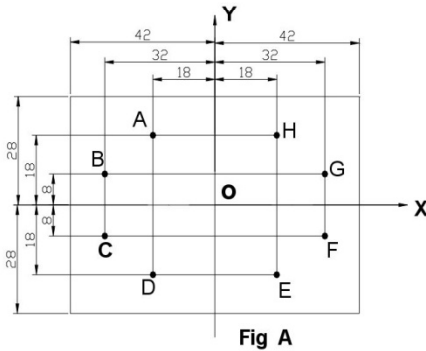

Fig A

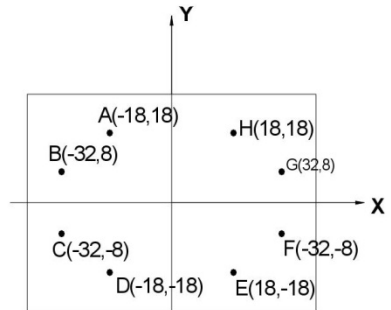

Fig B

Chapter 2 BASIC OPERATION

2.1 Power on

Function: Power on then DRO enter normal display state.

It can memorize the following parameter after power on.

- A. The scale position where power off;
- B. ABS/INC/SDM mode;
- C. Metric/Imperial mode;

NOTE:

- *When the power switch is turned on, press and hold the key ENT to enter the internal settings.*
- *If a linear scale is used for segment compensation, the system will prompt to find the RI point. If the linear scale is not moved after Power off, press the key CA to exit without find RI point.*

2.2 Zeroing

Function: Zero the designated axis in normal display state. Zeroing is used to set the current point as datum point.

NOTE:

- *When zero in ABS coordinate has no effect on INC display value. Zeroing in INC coordinate has no effect on ABS and SDM display value.*
- *Press the zero key of the same axis will cancel above zero operation if the scale kept still after zero.*

2.3 Preset Data to designed axis

Function:

Preset a value to current position for a designed axis in normal display state.

Example: Machine the work-piccc from the A to B

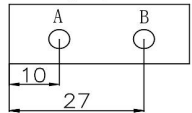

STEPS:

1. Move the machine table, and align the lathe tool to A.
2. Press X → 1 → □ → ENT, which means the preset data is “10”;

- Moving the machine table until “27.000” is displayed in X window.
Now it is the position of B.

2.4 Toggle display unit between mm and inch

Function: Length can be displayed either in “mm” (metric) or “inch” (imperial).
Display unit can be toggled between mm and inch.

Example: Display value toggle from mm to inch

STEPS:

- DRO returns normal display state. Press , the display unit is inch now.

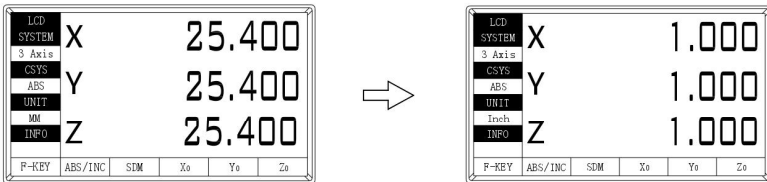

NOTE: It is invalid to toggle between mm and inch while axis is encoder.



2.5 Mid-point Calculation

Function: Set the center of work piece as datum by halving the displayed value.

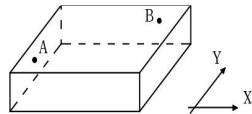



Example: Set the center of rectangle as datum as the right figure.

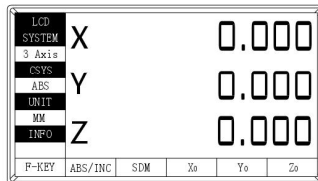
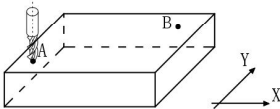

STEPS:

- Move machine table and align the lathe tool with point A;
Press  to zero X axis, press  to zero Y axis;



- Align lathe tool with point B by moving machine table;
Press  → ,  →  to halve the X and Y axis display value;

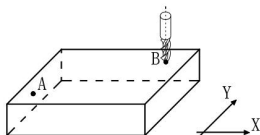

LCD SYSTEM	X	18.000
3 Axis	Y	12.000
CSYS	Z	0.000
ABS		
UNIT		
MM		
INFO		
P-KEY	ABS/INC	SDM
	Xo	Yo
	Zo	

3. Move the machine table until “0” is displayed in X window and Y window. The position (where the lathe tool is) is the work-piece’s center.

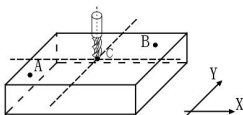

LCD SYSTEM	X	0.000
3 Axis	Y	0.000
CSYS	Z	0.000
ABS		
UNIT		
MM		
INFO		
P-KEY	ABS/INC	SDM
	Xo	Yo
	Zo	

NOTE: It is invalid to mid-point calculation while axis is encoder.

2.6 Absolute / Incremental / 500 groups SDM

Function: DRO has 3 display modes: the absolute mode (ABS); the incremental mode (INC) and 500 groups Second Data Memory (SDM) with the range of 001 to 500.

1. Zero point of work-piece is set at the origin point of ABS coordinate;
2. The relative distance between datum of ABS and SDM remains unchanged when ABS datum is changed.
3. In ABS coordinate. The coordinate value is black;
In INC coordinate. The coordinate value is blue;
In SDM coordinate. The coordinate value is red;

I. Toggle among ABS/INC/SDM coordinate

These three display modes can be changed only in normal display state.

Press key or or , the display modes can be changed between ABS、INC and SDM

II. Set the new number of SDM in SDM mode

STEPS:

1. Press key , message window display “InputSDM” , waiting for

inputting a new number of SDM;

2. Enter a new number. for example, enter a

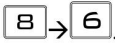

3. Press , then the number of SDM is changed to 86.

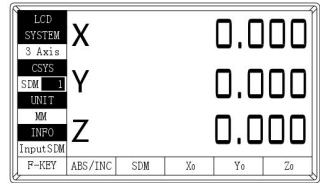

III: Increase/Decrease the SDM number

DRO return normal display state with the display mode SDM, press to decrease the number of SDM by 1; press to increase the number of SDM by 1.

2.7 Clear All SDM Datum

Function: Clear the Datum of all SDM 1 - 500. After clearing, the display value in SDM coordinate is equal to the value in ABS coordinate.

STEPS:

1. Return normal display state;
2. Press , Enter "Function" interface , Press or to select

“Reset SDM”, then press key

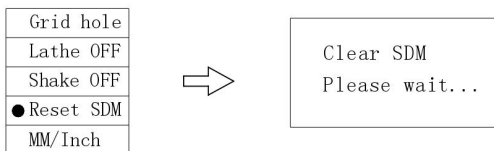

2.8 Lathe Function

If two scales are installed in one axis, the position of the work-piece should be the sum of these two values in this direction. It is called lathe function.

lathe mode is “NULL” : normal display.

lathe mode is $X=X+Y$:

X window value = value of X axis position + value of Y axis position.

lathe mode is $X=X+Z$:

X window value = value of X axis position + value of Z axis position.

STEPS:

1. Set the lathe mode in initial system settings;
2. In normal display state press F1 Enter "Function" interface.
3. Press ▲ or ▼ to select "Lathe", then press key ENT

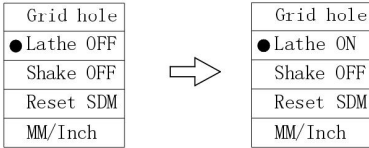

2.9 Filter display value

When machine a work-piece by grinder, the display value varies quickly due to the vibration of grinder. User can't see display value clearly. DRO provides display value filter function to disable the quake change of display value.

STEP:

1. In normal display state, press F1, enter "Function" interface.
2. Press ▲ or ▼ to select "Shake", then press key ENT

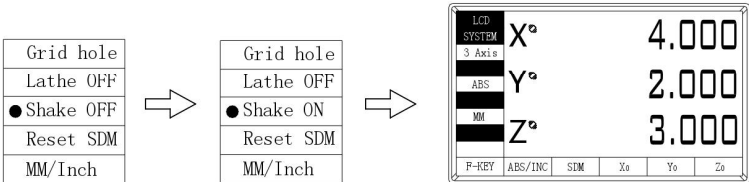

Note: The icon " indicates that the digital filtering function is valid.

2.10 Close the screen

In order to extend the life of the LCD, when the customer is not using the digital display, can press key ⏻ to turn off the LCD display. When the LCD display is turned off, it does not affect the counting function of the digital display.

When the LCD screen is off, pressing any button will open the display.

Chapter3

500 groups SDM coordinate

DRO has three display modes: the absolute mode (ABS), the incremental mode (INC) and the 500 groups second data memory (SDM 1—SDM500).

ABS datum of the work-piece is set at the beginning of the processing and the 500 group SDM is set relative to ABS coordinate.

500 group SDM coordinate can be divided into several segments, and every segment stores data of one work-piece. For example, if one segment has 20 groups SDM coordinate, DRO can be divided into 25 segments and can store data of 25 work-pieces.

Example: The ABS datum is the center point O, the point A, B, C, D needed processing are set as datum of SDM 001 —SDM 004.

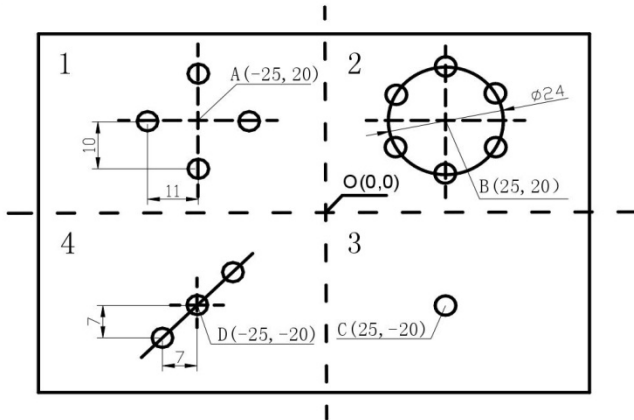

Two ways to set SDM coordinates:

- 1) Zeroing at the current point.
- 2) Presetting datum of SDM coordinate.

3.1 Zeroing at the Current Point

At first set the center point of the work-piece as the origin of the ABS, then align the lathe tool with point A, B, C, D by moving the machine table and zero them. It is the position to process where the “0.00” appears in X window, Y window by moving the machine table whether in ABS or in SDM coordinate.

STEPS:

1. Set the center of rectangular point O as the datum of ABS

Make line L1 parallel with X axis: line L2 parallel with Y axis.

When position lathe tool to point O
 Zero X axis and Y axis in SDM 001;
 Zero X axis and Y axis in SDM 002;
 Zero X axis and Y axis in SDM 003;
 Zero X axis and Y axis in SDM 004;

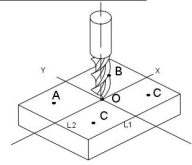

- Set the point A as the datum of SDM 001.
 SDM 001: align the lathe tool with point A and zero X axis, Y axis.

Press X_0 、 Y_0

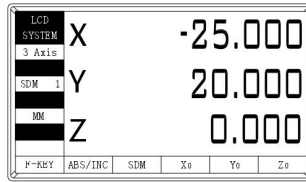
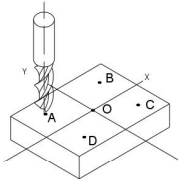

- Similarly, use the same way to set the three auxiliary points B, C and D.
- Machine the work-piece according to the preset SDM coordinate;
- Machine another work-piece according to the same blueprint. You only need set the center point as the datum of ABS. It is not necessary to set SDM coordinate again, as SDM can be set automatically. Point A, B, C, and D is the zero point of SDM 001, SDM 002, SDM 003, and SDM 004 respectively. Point can be machined when enter corresponding SDM coordinate and “0” appears in screen by moving machine table. This function can save great plenty of time in production.

3.2 Preset datum of SDM Coordinate

Compared with the way of zeroing at current point, the another way (presetting datum of SDM coordinate) can set zero point of SDM more accurately and quickly without moving the machine table.

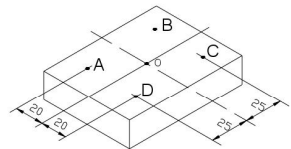

As the figure showed right, center point is the datum of ABS, the position of point A, B,C, D is (-25, 20), (25, 20), (25, -20), (-25, -20) in ABS coordinate.

A Enter SDM 001 and preset the position of point O as (25, -20), which

means the point A is the datum of SDM 001;

- B Enter SDM 002, preset the position of point O as (-25, -20), which means the point B is the datum of SDM 002;

Pay attention that the preset value is negative to the actual value of position in ABS. If set “SDM DIR” as “reverse” in system settings, the caution is not necessary. The value DRO accepts is equal to the negative of the enter value.

STEPS:

1. Set “SDM DIR” as “reverse” in initial system settings;
2. Set the center point of the work-piece as the datum of ABS;

Line L1 is parallel to X axis, line L2 is parallel to Y axis.

Move machine table, align the milling cutter with point O. The machine table remain still while presetting;

- 1) Set point A as the datum of SDM 001;

The position of point A is (-25, 20)

press.

X	→	2	→	5	→	±	→	ENT
Y	→	2	→	0	→	ENT		

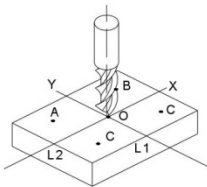

- 2) In the same way, the same step is used to set the auxiliary zero position for the two points B C and D.

NOTE:

- *The SDM preset number direction is set in the internal settings.*
- *In SDM state, Preset number direction is set to positive, means that the display value is equal to the enter value; Preset number direction is set to reverse, means that the display value is equal to the negative of enter value.*

Chapter 4 SPECIAL FUNCTIONS

DRO has special function as the following except measuring and positioning:

Bolt Hole Circle (BHC);

Bolt Hole Line (BHL);

Bolt Hole Grid (BHG);

ARC Processing ;

Slope Processing;

Note: Please refer Coordinate System (in Chapter 1) before reading this section.

4.1 Bolt Hole Circle

Function description:

DRO has the function of BOLT HOLE CIRCLE (BHC). This function can simplify the pressing of multiple holes which are attributed equally around the circumference of a circle. The DRO will guide operator to enter the following parameters:

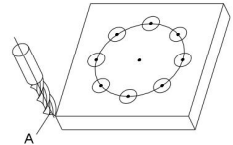

Radius	Circle radius to be machined
Start angle	Starting angle that the center of the first hole on the circle
End angle	Ending angle that the center of the last hole on the circle
Holes number	Number of holes to be machined
Direction	Processing direction(CCW or CW)

Angle has two directions: counterclockwise(CCW) and clockwise(CW). “CCW” indicates that it is counterclockwise from Start angle to End angle; “CW” indicates it is clockwise from Start angle to End angle. As the following figure, the Start angle is 0° , End angle is 240° .

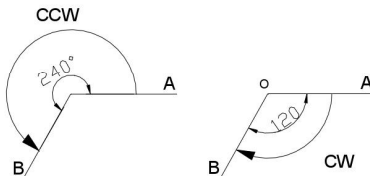

As figure illustrates, machine a hole every 45° from $0^\circ \sim 225^\circ$. Parameters are as the following:

Radius	30
Start angle	45°
End angle	225°
Holes number	5
Direction	CCW.

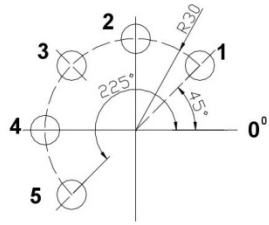

NOTE: If *ST.ANGLE* equals *END.ANGLE*, the holes are attributed equally around the whole circumference.

The positions of the hole center are calculated automatically after input all parameters. Press or to choose the hole No. and move the machine table until the “0” appears in X window, Y window. It is the position to process a hole.

Example: Machine holes on circumference as the figure.

Radius	100
Start angle	0°
End angle	315°
Holes number	8
Direction	CCW.

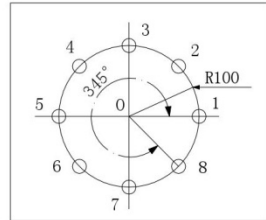

STEPS:

1. Set display unit to metric in normal state;
2. Move the machine table until the machine tool is aligned with the center of the circle, then zero X axis, Y axis.

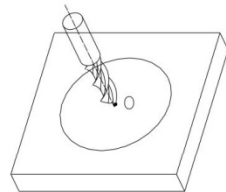

3. Press to enter Bolt Hole Circle function.
4. Input all parameters, press to start processing.

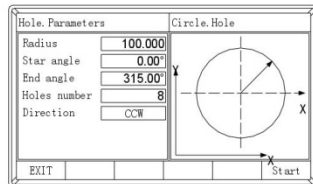
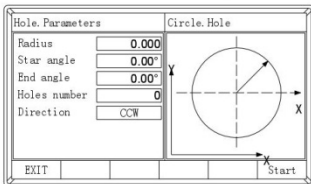

5. Press the function key to start processing
6. The current point is displayed as “ 1”;

It is the position of the first hole to punch where the “0” is displayed in X window and Y window by moving the machine table.

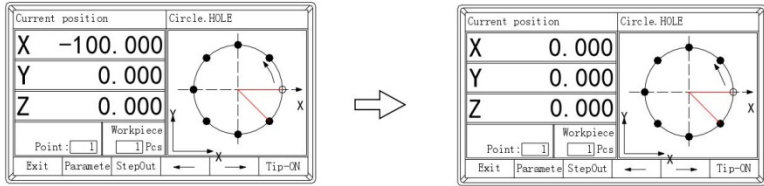

- After finishing the first hole, press the current point is displayed as “2”; Move the machine table, the “0” is displayed in X window and Y window. It is the position of the second hole.

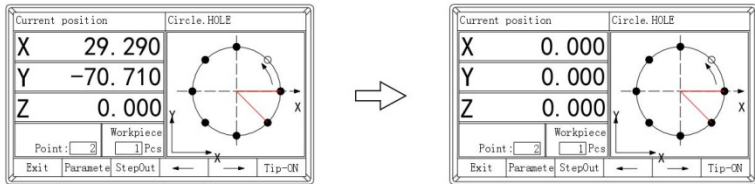

NOTE: Press or to change holes number.

- Process the remaining holes in the same way.
- After processing all holes, press or **F1** to return normal display state.

NOTE:

Press the key **F2** during machining to view the machining parameters

Press the key **F3** during machining to temporarily leave the current machining state.

Press the key **F6** during the machining process to open or closing prompt message (when the machining is finished, prompt the current workpiece processing is completed).

4.2 Bolt Hole Line

Function: DRO provide BOLT HOLE LINE (BHL) function. This function can simplify the processing multiple holes whose centers are attributed equally on one line.

In order to facilitate customer processing, Bolt hole line provides two processing methods, as shown below.

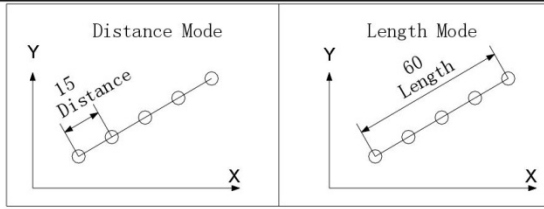

The following parameters are needed to be input:

- Mode Distance mode and Length mode
- Length Distance between the center of first hole and the center of the last hole(Length mode)
- Distance Distance between the holes (Length mode)
- Line angle Angle between the line and the positive X axis
- Holes number Number of holes to be machined

DRO will calculate the positions of the hole after all the parameters have

been entered. Press or to select the No of hole and move the machine until “Q” is displayed in X window and Y window. It is the position of hole to machine.

Example:

- Mode Length
- Line length 45.000mm
- Line angle 30°
- Line number 4

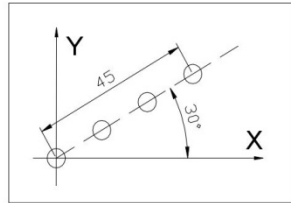

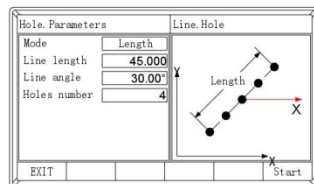
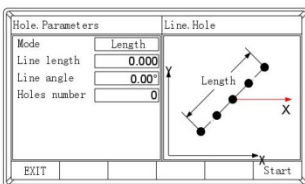

STEPS:

1. Set display unit to metric
Move the machine table until the machine tool is aligned with the center point of the first hole, and zero X axis, Y axis.
2. Press to enter BOLT HOLE LINE function;
3. Input all parameters, press to start processing.

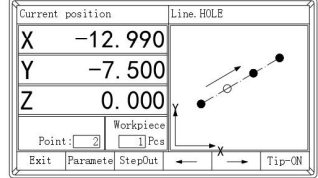
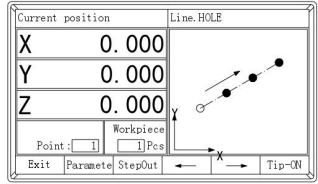

4. The current point is displayed as “ 1 ”;
Move the machine table until “0” appears in X window and Y window, it is the center of the first hole to punch.
5. After finishing the first hole, press  , and the current point is displayed as “ 2 ”;
Move the machine table until “0” appears in X and Y window, and then you can punch the second hole at this point.



NOTE: Press  or  to transform among holes.

6. Process the remaining holes in the same way.
7. Press  or **F1** to return normal display state when finishing processing.

4.3 Bolt Hole Grid

Function: This function can calculate the position of every processing point automatically in processing grid. Only the following parameters need to be inputted:

Type	Gride or Frame
Start-X	The X start coordinate of the first hole
Start-Y	The Y start coordinate of the first hole
Distance-X	Distance between holes in the X direction
Distance-Y	Distance between holes in the Y direction
Angle	The angle between the grid(or fram)and the X axis
Number-X	Number of holes to be machined in the X-axis direction
Number-Y	Number of holes to be machined in the Y-axis direction

Example :

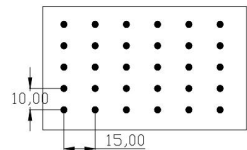

Machining the workpiece shown in the figure, The parameters are as following

Type	Gride
Start-X	0
Start-Y	0
Distance-X	15.000
Distance-Y	10.000



Angle 0.000°
 Number-X 6
 Number-Y 5

1. Return normal display state;

2. Press **F1**, Enter "Function" interface , Press  or 
 to select "Grid hole", then press key **ENT**

3. Input all parameters, press **ENT** to start processing.

<input checked="" type="checkbox"/> Grid hole
Lathe OFF
Shake OFF
Reset SDM
MM/Inch

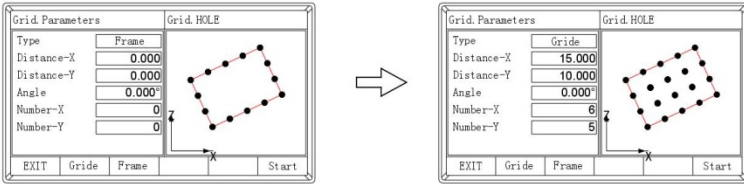



4. Press the function key **F6** to start processing

5. The current point is displayed as " 1";

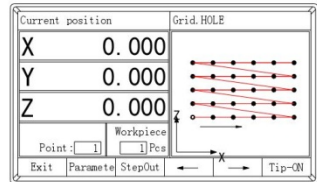
Move the machine table until "0" appears in X window and Y window, it is the center of the first hole to punch.



NOTE: Press  or  to transform among holes.

8. After finishing the first hole, press , and the current point is displayed as " 2";move the machine table until "0" appears in X and Y window, and then you can punch the second hole at this point.

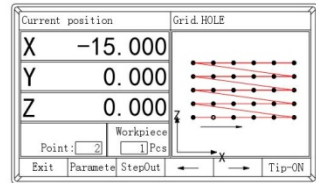

NOTE: Press  or  to transform among holes.

9. Process the remaining holes in the same way.

10. Press **F1** to exit ARC processing after machining is over.

4.4 ARC Processing

It is waste to using numerical control lathe to process arc in the simple product or small production. This function makes it convenient to process arc with normal lathe. Parameter "Max cutting" is the arc length each process. The smaller the Max cutting, the more smooth the arc plane and the longer processing time.

A. Process XZ, YZ plane

There are 8 modes as the following when processing arc in XZ or YZ plane:

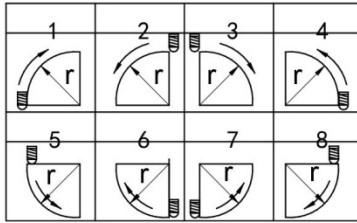

NOTE: Milling cutter may be flat-bottomed or arc-bottomed. If flat-bottomed, set the tool diameter as 0;

B. Process XY plane

DRO provides the above 8 modes in processing XY plane. The milling cutter is perpendicular to the machine plane. DRO has internal ARC processing and external ARC processing for each type:

Process Type (when process XY plane)

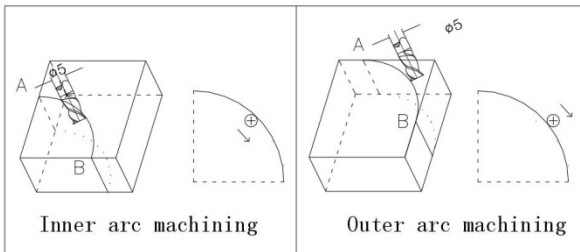

Set the tool radius according to the actual milling cutter when process XY plane.

Enter the following data for ARC processing:

- | | |
|---------------|----------------------------------|
| Process plane | Plane of the ARC processing |
| Process model | Mode of the ARC processing |
| ARC Radius | Arc radius to be machined |
| Tool dia | Tool diameter |
| Step model | Feed step |
| Max cutting | Maximum cutting amount |
| Process type | Outside or inside(XY plane only) |

NOTE: The step mode of the XY plane is only MAX CUT mode, there is no Z STEP mode.

Description of MAX CUT, Z STEP reference Slope Processing

Example :

Process an arc AB of 90° from point A to point B as the figure.

Parameters are as the following:

- Process plane XY
- Process model Mode 3
- ARC Radius 20mm
- Tool dia 5mm
- Step model MAX CUT
- Max cutting 1mm
- Process type Outside

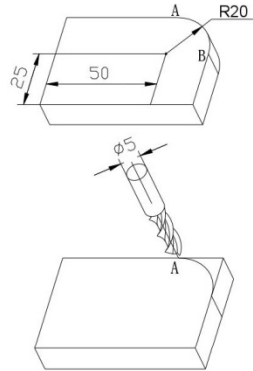

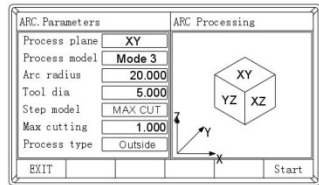
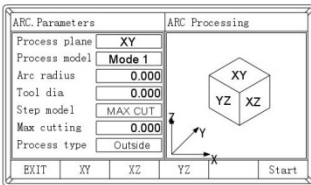

STEPS:

1. Set display unit is metric
2. Move the machine table until the lathe tool is aligned with point A, then zero X axis and Y axis;
3. Press  to enter ARC processing state.
4. Input all parameters, press to start processing.



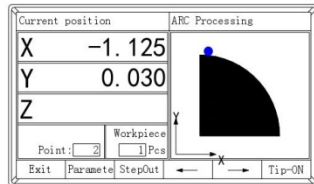
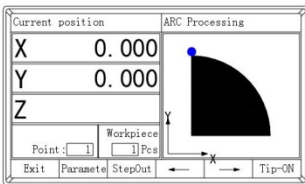



5. Process ARC, the current point is displayed as "1". Process when the "0" appears in X window and Y window. Then you have finished the first point. Press  to switch to the second point and repeat the same step.



NOTE: Press  or  to transform among holes.

6. Press  to exit ARC processing after machining is over.

NOTE: For DRO of 2 axes, it is not installed with Z-axis, please press  or  to simulate position of Z-axis,  simulate moving to the former process point, and  simulate moving to the next process point.

Steps:

- 1: Before machining, at first, align lathe with the beginning point Z of R, zero Z axis;
- 2: In machining process, message window displays simulate height of Z axis, which indicates simulate height of Z axis while machining;

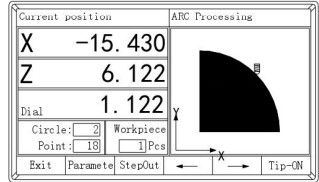

As right figure, while machining XZ plane, X window display position of X axis, X axis is finished when displaying “0” in X window, Z window displays the Z-axis simulation height, which indicates the Z-axis height when the current machining point stops machining. The number of turns and the ring ring scale ,which means that machining to this scale for current point.

4.5 Slope Processing

Function: This function can calculate the position of every processing point automatically in processing slope. Only the following parameters need to be inputted:



- Process plane Set machine plane XY, YZ or XZ plane
- INCL angle the inclination angle of the slope
- Step model MAX CUT or Z STEP

NOTE:

Z STEP and MAX CUT are defined as the figure.

MAX cutting the slope length each time processing

DRO will calculate the position of each processing on the slope

automatically when all parameters have been input. Press  or  to select the processing point and process until “0” appears in the window.

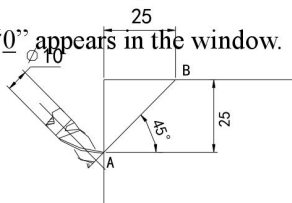
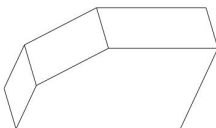

Example :

Process the slope AB as the figure. The parameters are as following:

- Process plane XZ
- INCL angle 45°
- Step model Z STEP
- MAX cutting 1mm

STEPS:

1. Set display unit to metric;

Move the machine table until the lathe tool is aligned with the starting point A, then zero X axis and Z axis.

Press X_0 , Z_0 in normal display state.

2. Press  to enter slop processing

3. Input all parameters, press ENT to start processing.

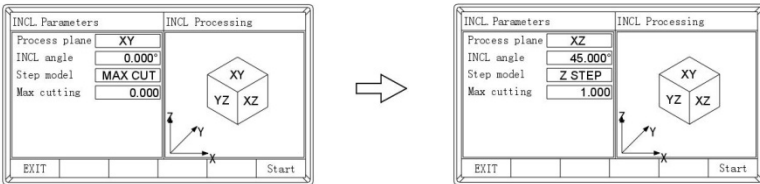

4. Process ARC, the current point is displayed as “1”. Process when the “0” appears in X window and Y window. Then you have finished the first point.

Press \blacktriangledown to switch to the second point and repeat the same step.

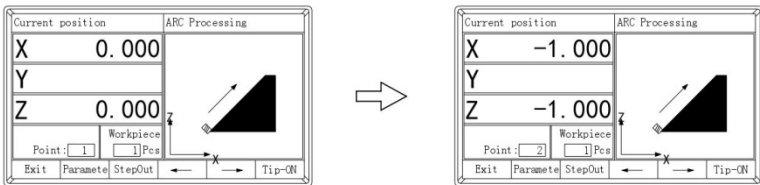

5. Press  to return normal display state after processing is over.

NOTE: For DRO of 2 axes, it is not installed with Z-axis, please press \blacktriangle or \blacktriangledown to simulate position of Z-axis, Please refer to arc machining.

Chapter 6 CALCULATOR

DRO provides arithmetic operation such as plus, minus, multiply and divide, which convenient for operator to processing work piece according to the drawing.

● Enter and exit Calculator Function

In normal display state: press  to enter calculator function

In calculator state: press  to exit calculator function

Current Position			Calculator		
X	0.000				0
Y	0.000		X _o Y _o Z _o	Calculator → Position	
Z	0.000		X _i Y _i Z _i	Position → Calculator	
Inv	Sin	Cos	Tan	√	返回
+	-	×	÷	Π	=

● Calculating Example

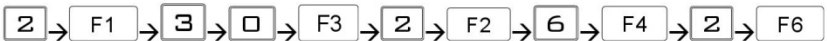

Example 1: $2+30\times 2-6/2=59$

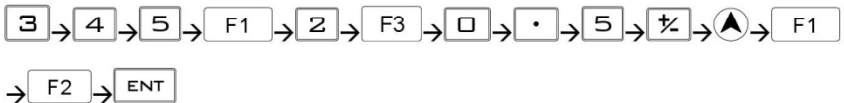

Example 2: $345+2\times \sin^{-1}(-0.5)=285$



NOTE:

1. If incorrect data is inputted, press  to cancel and input again.
2. Error would occur when calculating incorrectly, such as "0" is used as divisor or proceeding arcsine when absolute value is more than 1. In this case, the message window will display "ERR..." You can cancel this error message by pressing  and input data again.
3. The absolute value of inputted data and calculated result should be in the range of 0.000001 to 9999999, otherwise it can't be displayed.

- **Transferring the Calculated Results to Selected Axis**

After calculating is finished:

press X_0 , Y_0 , Z_0 , to transfer the calculated result to X,Y,Z, axis, then the window will display this value.

- **Transferring the Current Display Value in Window to Calculator**

In calculator state:



press X , Y , Z , to transfer the display value in X,Y,Z window to calculator.

Chapter 7 INITIAL SYSTEM

Function: Set various parameters according to actual operation.

System setting、Resolution setting、Direction、Linear compensation、Section compensation、Axis type、Radius/Diameter mode、RS232 and other setting.

7.1 Enter/Exit Initial System Settings

Touch-hold "  " button to enter initial system setting after DRO powers on in 2 second, Press  or  to select the item you want to change.

press  to quit system settings.

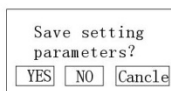
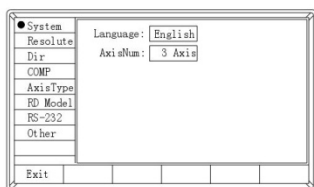

7.2 System Parameter

system language:

Chinese and English.

Interface type of axes :

axes and 3axes

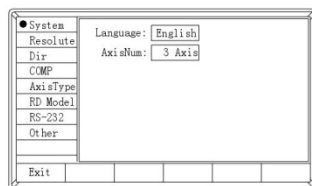

7.3 Setting the Resolution of scale

Linear scale:

Different scale has different resolution. DRO can connect with 10 kinds of scale, and these resolutions are 0.05 μ m, 0.1 μ m, 0.2 μ m, 0.5 μ m, 1 μ m, 2 μ m, 5 μ m, 10 μ m, 20 μ m, 50 μ m. The resolution must be set to match the linear scale.

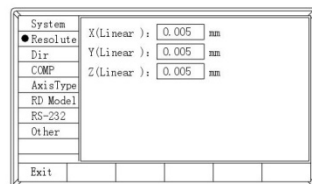

Encoder:

When the encoder is connected, the resolution is the number of pulses

emitted by the encoder during one revolution.

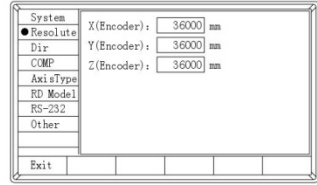

7.4 Setting Direction for Counter

After the user installs the scale, the actual counting direction may be exactly the opposite of what the user expects, and the user's needs can be solved in the internal setting. The direction of the scale is set by the installer and the user should not change it.

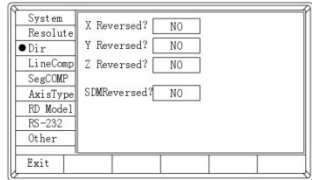

7.5 Setting Linear Compensation

Definition









Linear error: There is always an error between actual measure value and standard value. If it is distributed around the scale travel linearly, the error is defined as linear error.

Linear compensation: Compensate the linear error to make display value equals to standard value.

NOTE: *The linear compensation is set by erector. Operator had better not change it, or the accuracy of linear scale will be worse.*

7.5.1 Manually compensate

For example(X Axis):

1. In the internal settings, press  or  to select compensation.
2. Press the key  to enter compensation, press  ,  ,  to select the axis to be set.
3. Press key  move to "COMP Mode" and press key  to select linear compensation

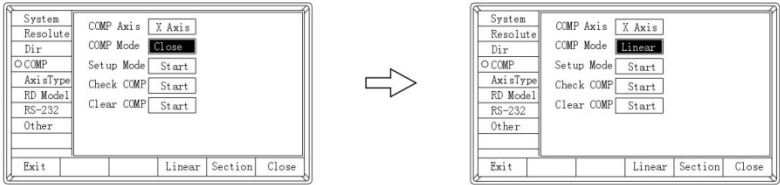

4. Press key move to “Setup COMP” and press key to start compensation .

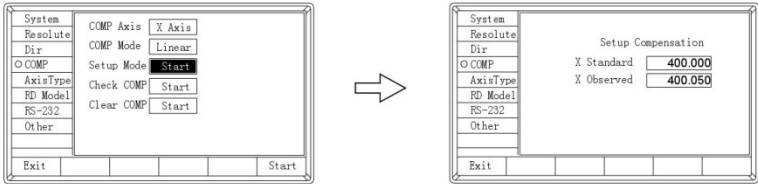

Example: The scale valid length is 400mm. If the measure value is 400.040mm and the standard value is 400mm.

Enter the standard value 400.000 and the observed value 400.050 on the corresponding number axis.

Note : *If the compensation value is not compensated correctly at one time and needs to be compensated again, then the previous standard value and the observed value must be set to the same value, for example, both are set to 1, or the compensation mode is set to close, and the second compensation can be performed. Otherwise, the second compensation is based on the first time, then the data is absolutely incorrect.*

7.5.2 Automatic compensation

Operating steps (Take the X axis as example)

1. Touch-hold " " button for 3 seconds, enter into the mode of X axis automatic compensation, the X axis blinks.
2. As shown in the figure, put the standard gauge blocks on top of the workbench, move X axis to align with the A plane, press the " " key, and reset.

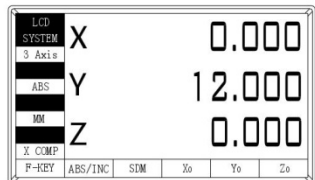
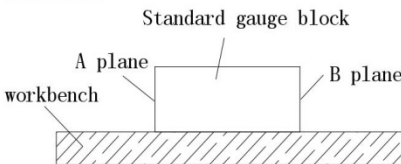

3. Move X axis to align with the B plane, press the " " key, window will show "X Axis set ok", then the linear compensation of X axis finished

NOTE:

- *Standard gauge block must be integer times of 10 mm (for example: 10 mm, 20 mm, 30 mm...). If not, please manually compensate.*
- *During automatic compensation, pressing the AC key can exit automatic compensation function, and the previous compensation value will not change.*
- *INC and SDM coordinates cannot automatically compensate, inch system cannot automatically compensate, only under the ABS and metric system, can enter into automatic compensation function.*
- *After compensation, values can be checked in internal parameter set.*

7.6 Setting Section Compensation

In the case where the number axis type is a scale:

Nonlinear error: There is an error between the measured value of the scale and the standard value. The error is nonlinearly distributed in the stroke range of the scale, which is called nonlinear error.

The linear compensation of the segment is to divide the whole scale into n segments, and the error is considered linear in each segment, respectively, and a compensation value is given; when counting, it is calculated according to different compensation values in different segments.

Operation steps (X axis as an example):

1. In the internal settings, press or to select the compensation.
2. Press the key to enter the section compensation, press 、 、 to select the axis to be set.
3. Press key move to “COMP Mode” and press key to select section compensation.

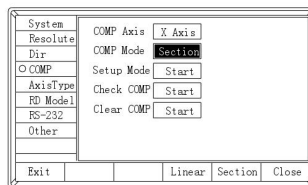
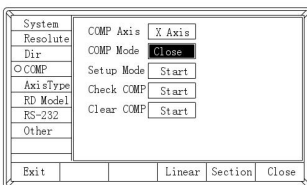

Angle type: percentage and degree minute

Angle type: $0-360^0$, $-360-360^0$, $-180-180^0$

7.8 R/D Display Mode

In common case, the display value is the distance between lathe tools and the coordinate origin. This display mode is Radius mode. When process cylinder given diameter measurement, diameter is the double distance between lathe tool and coordinate datum. The DRO will display the diameter in Diameter mode

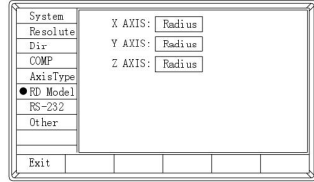

7.9 RS-232

Sometimes, the user needs to transfer the current display value to the computer display. At this point, the user needs to decode according to the communication protocol of the digital display to display the data transmitted to the computer, and the specific communication protocol can contact the agent.

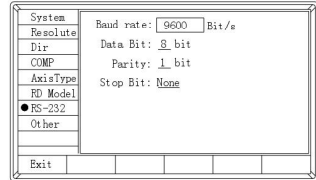

7.10 Other Setting

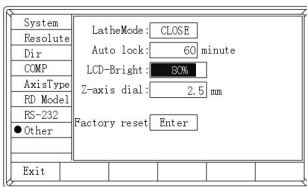

There are two types of lathe mode:

lathe mode is $X=X+Y$:

X window value = value of X axis position + value of Y axis position.

lathe mode is $X=X+Z$:

X window value = value of X axis position + value of Z axis position.

After setting the lathe mode, you can press the key F1 on the normal display interface to enter the function selection interface and select to turn the lathe function on or off.

Screen protection time

It can be set to 30, 60, 90, or 120 minutes, or you can choose to turn off the screen protection function.

NOTE: *In the screen protection state, you can exit by pressing any button or moving the scale.*

LCD-Bright

Press and hold or to increase or decrease the screen brightness.

Z axis Dial

Z axis Dial should be set if Z axis is emulated for DRO of 2axes and only install linear scale for X, Y axis.

Z axis Dial means the distance the Z axis travels when screw runs a revolution.

NOTE: *In the case of ARC Processing and Slope Processing, it is used only when the z-axis is not installed.*

Factory rest

Prompt for the password. After completing the password entry, press the key to start the Factory rest.

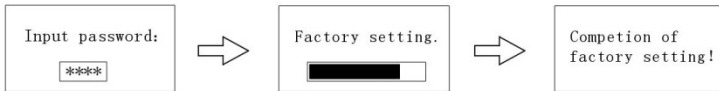

The default setup for all parameters is as following:

- Resolution 5 μ m;
- Counting direction: Positive
- Input mode in SDM: display value = input value;
- Compensation: off
- Interface type: Linear scale
- Angle type :DD
- Angle mode: 0⁰-360⁰
- R/D mode: Radius mode
- Baud rate: 9600
- Lathe mode: off
- Screen protection time: 60 minutes
- Z-axis Dial: 2.5mm

Chapter 8 TROUBLE SHOOTING

The following are the easy solvent for troubleshooting. If they can not work: please contact with distributor for more service.

Trouble	Possible Reason	Solvent
No display	A The DRO isn't powered. B AC power voltage is not in the range of 100V to 240V C LCD screen is damaged	A Check the fuse is OK or not. Check the socket is loose. B Check the input power voltage is in the range of 100V to 240V. C Replace the LCD screen
Cover is charged	A Poor grounding is float B Leakage of electricity	Check the lathe and DRO are well grounded.
Display value is doubled	A Improper resolution B check lathe mode	A Set proper resolution. B Set lathe mode off.
No counting	A Poor contact of scale B No scale signal output C Useless of counting function	Exchange scale and check again.
Display value is in disorder	Memory is disorder	A Clear system. B Check compensation is proper.
Erroneous counting	A Poor precision of lathe B Too fast run speed of the lathe C Proper scale precision D Improper resolution is set E Improper linear error compensation F Useless of scale	A Repair lathe. B Reduce the move speed of scale. C Reinstall scale. D Set proper resolution. E Set proper linear error compensation. F Repair or exchange linear scale.