

VEVOR[®]

**CAP HEAT PRESS MACHINE
USER MANUAL**

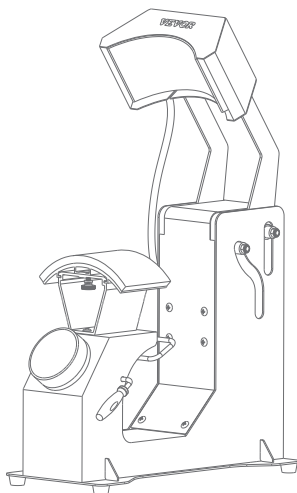

76*155MM



70*168MM



98*168MM

Accessories are optional for different sizes of caps

NEED HELP? CONTACT US!

Have product questions? Need technical support? Please feel free to contact us:

CustomerService@vevor.com

This is the original instruction, please read all manual instructions carefully before operating. VEVOR reserves clear interpretation of our user manual. The appearance of the product shall be subject to the product you received. Please forgive us that we won't inform you again if there is any technology or software updates on our product.

SAFETY INSTRUCTION

When using electrical appliances, basic safety precautions should always be followed including the following :



Warning-To reduce the risk of injury, user must read instructions manual carefully and save these instruction.

Description of the symbols

	This symbol, placed before a safety comment, indicates a kind of precaution, warning, or danger. Ignoring this warning may lead to an accident. To reduce the risk of injury, fire, or electrocution, please always follow the recommendation shown below.
	This product is subject to the provision of European Directive 2012/19/EC. The symbol showing a wheeled bin crossed through indicates that the product requires separate refuse collection in the European Union. This applies to the product and all accessories marked with this symbol. Products marked as such may not be discarded with normal domestic waste, but must be taken to a collection point for recycling electrical and electronic devices.
	This device complies with Part 15 of the FCC Rules. Operation is subject to the following two conditions: (1) This device may not cause harmful interference, and (2) this device must accept any interference received, including interference that may cause undesired operation.

WARNING

1. Warnings must be followed carefully to avoid body injury, Improper-use may result in electric shock, fire, personal injury and other damage:

- 1) Keep unplug when moving the machine.
- 2) keep unplug when installing accessories.
- 3) Place on a flat and stable platform and operate under ventilated conditions.
- 4) Wear special protective equipment when operating the machine
- 5) Do not use this machine in a hazardous-location.
- 6) Do not use when the machine is not working properly.
- 7) Do not disassembly and repair this machine.
- 8) Do not use an unsuitable AC outlet.
- 9) Do not touch the heating plate when the machine heating
- 10) Do not use in humid environment or contact with water. Do not infiltrate liquid in the machine to prevent fire or electric shock caused by short circuit.
- 11) Do not use the power supply that does not meet the rated voltage, The power supply that does not meet the specified voltage may cause fire or electric shock.
- 12) Ensure that the machine is grounded so as not to cause harm to body.
- 13) Do not touch the rotating rod or bearing part with your fingers during use in case of injuries.
- 14) If the machine is not in use for a long time, please unplug the power cord from the socket.
- 15) Do not use the machine during thunderstorms or lightning to avoid damage to the machine.
- 16) Place the machine smoothly on the flame-retardant table and keep away from inflammable and explosive items.
- 17) If the machine smokes, emits peculiar smell, becomes noisy and other abnormal conditions, please stop using.
- 18) This appliance can be used by children aged from 8 years and above and persons with reduced physical, sensory or mental capabilities or lack of experience and knowledge

if they have been given supervision or instruction concerning use of the appliance in a safe way and understand the hazards involved. Children shall not play with the appliance. Cleaning and user maintenance shall not be made by children without supervision

2, Type X attachment: If the supply cord is damaged, it must be replaced by a special cord or assembly available from the manufacturer or its service agent.

3, In order to avoid a hazard due to inadvertent resetting of the thermal cutout, this appliance must not be supplied through an external switching device, such as a timer, or connected to a circuit that is regularly switched on and off by the utility.

INTRODUCTION

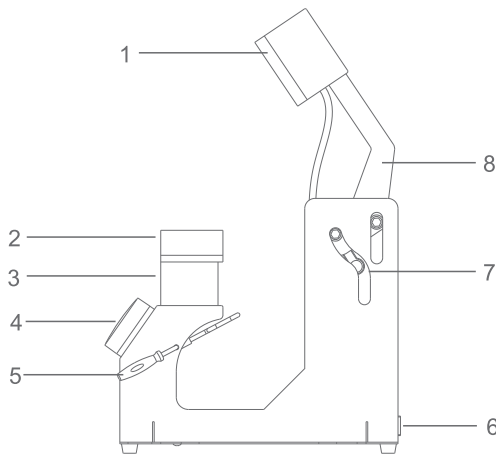

1.Heating plate 2.Cap support 3.Cap support seat 4.LED switch
5.Cap holder 6.Power socket 7.Guide wheel 8.Bracket

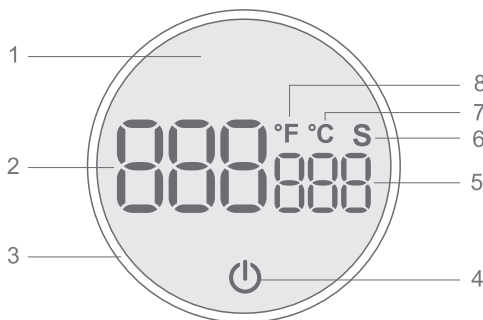

1.LOGO 2.Temperature display 3.Knob switch 4.Start button
5.Time display 6.Time unit 7.Centigrade 8.Fahrenheit

Accessories list



Main machine



76*155MM



70*168MM



User manual



Power cord



98*168MM

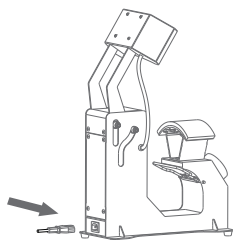

Getting Started

1. Connect the power cord to the power port on the side of the machine and insert the other end into the AC socket.

2. Startup

After power on, short press the power button to start the machine.

After startup, the machine will automatically heat up.

3. Shutdown

Press and hold the power button for 3s to shut down.

4. Auto shutdown

The machine will automatically shut down if there is no operation within 30min.

Replacement of cap support:

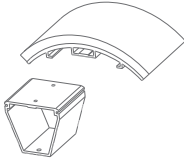

1. Select the cap support to be replaced

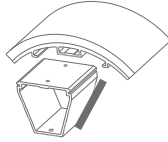

2. Insert into the seat slot

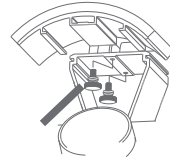

3. Fix with screws



170 °C S
20

Transfer material: PET film
Turn the switch to the right to set the temperature to 170°C.
Turn the switch to the left to set the time to 20s.



200 °C S
60

Transfer material: Heat transfer paper
Turn the switch to the right to set the temperature to 200°C.
Turn the switch to the left to set the time to 60s.

Temperature unit conversion

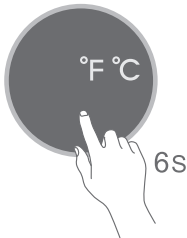

°F ⇌ °C

1. In shutdown state.
2. Press and hold the start button for 6s.
3. Turn the switch to select the required temperature unit.
4. Short press the start button to start the machine.



Temperature setting

1. Turn the display half a turn to the right.
2. Enter the temperature setting mode after a beep sound
3. Turn the switch to the right to increase the temperature (+)
4. Turn the switch to the left to reduce the temperature (-)

It is normal that the temperature will be slightly higher when the machine works for the first time.



Time setting

1. Turn the display half a turn to the left
2. Enter the countdown setting mode after a beep sound
3. Turn the switch to the right to increase the time (+)
4. Turn the switch to the left to reduce the time (-)



1. Cap to be printed



2. Turn on the heating plate to increase the temperature

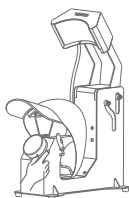

3. The heating plate automatically presses down after pressing the button

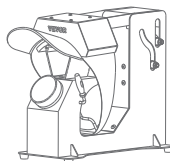

4. The machine automatically opens after countdown

Electrical diagram

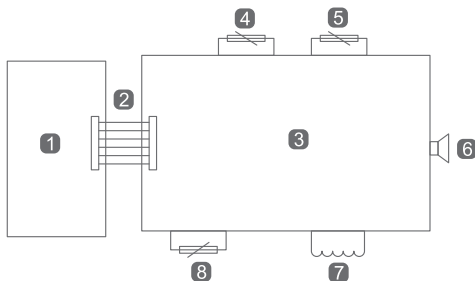

- | | | | |
|------------------------------|-----------------------------|----------------|--------------------------|
| 1 Main control circuit board | 2 Connecting the flat cable | 3 Power board | 4 NTC temperature sensor |
| 5 Magnetic switch | 6 Buzzer | 7 Heating coil | 8 Thermal Fuse |

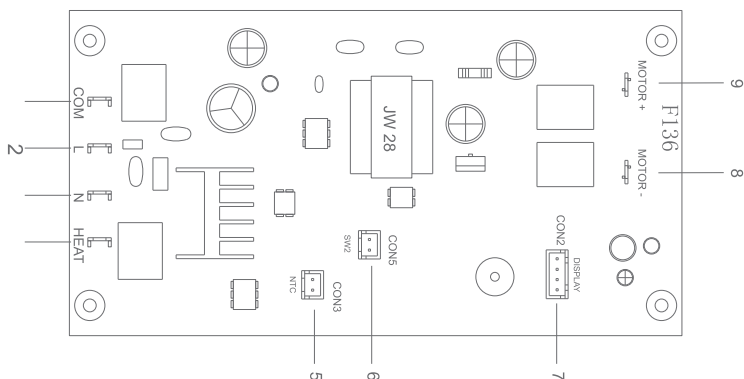

- | | |
|----------------------|------------------|
| 1. Output zero line | 6. Sensor switch |
| 2. Input zero line | 7. Display |
| 3. Input live line | 8. Motor- |
| 4. Output live line | 9. Motor+ |
| 5. Temperature probe | |

PRODUCT PARAMETERS

Name: Cap heat press machine	
Heating method: Mica heat	
Rated voltage/frequency: 220-240V~ 50Hz 310W For European users	
Rated voltage/frequency: 120V~ 60Hz 350W For US users	
Temperature range: 40°C-210°C(104°F-410°F)	Time range: 1-999s
Model: F136	
Press pad size: MAX:98*168MM	
Net weight: 7.2kg Gross weight: 8.1kg	
Outer box size: 420*200*395MM	

WARRANTY

Type	Items	Period
Whole machine	Parts of machine (excl. accessories)	1 year

COMMON FAULT ANALYSIS

Fault phenomenon	Faults Causes and Solutions
Machine temperature does not rise	Reason1: The aviation connector wire is not properly inserted. Reason2: The electric power of the mug pad is broken. Replacing the mug pad. Reason3: The main board has no current output (the main board does not supply power to the toast coaster). Replace the motherboard.
Display error	Reason1: Is that the aviation connector is not inserted properly. Reason2: Is the aviation joint temperature probe wire broken.

Manufacturer: Yiwu Sunmeta Technology. Co., Ltd
Address: NO.5 Xinpan Road, Shangxi Toen, Yiwu City, Zhejiang province, China

UK Importer: FREE MOOD LTD
Address: 2 Holywell Lane, London, England, EC2A 3ET
EU Importer: WAITCHX
Address: 250 bis boulevard Saint-Germain 75007 Paris

UK	REP	EUREP UK LTD UNIT2264, 100 OCK STREET, ABINGDON OXFORDSHIRE ENGLAND OX14 5DH
----	-----	--

EC	REP	EUREP GmbH Unterlettenweg 1a, 85051 Ingolstadt, Germany
----	-----	--

Made in China

VEVOR[®]

E-mail: CustomerService@vevor.com