

VEVOR®

TOUGH TOOLS, HALF PRICE

HEAT PRESS MACHINE F1210 USER MANUAL

We continue to be committed to providing you tools at competitive prices. "Save Half", "Half Price" or any other similar expressions used by us only represent an estimate of savings you might benefit from by purchasing tools with us compared to the major top brands and do not necessarily mean to cover all categories of tools offered by us. You are kindly reminded to verify carefully when placing an order with us if you are saving half in comparison with the top major brands.

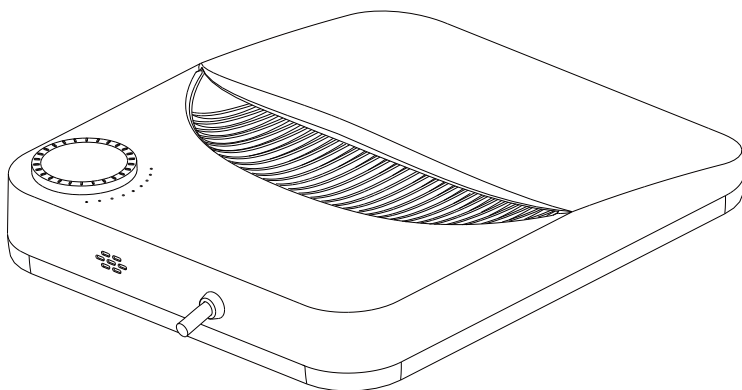

NEED HELP? CONTACT US!

Have product questions? Need technical support? Please feel free to contact us:

CustomerService@vevor.com

This is the original instruction, please read all manual instructions carefully before operating. VEVOR reserves clear interpretation of our user manual. The appearance of the product shall be subject to the product you received. Please forgive us that we won't inform you again if there is any technology or software updates on our product.

SAFETY INSTRUCTION

When using electrical appliances, basic safety precautions should always be followed including the following :



Warning-To reduce the risk of injury, user must read instructions manual carefully and save these instruction.

Description of the symbols

	This symbol, placed before a safety comment, indicates a kind of precaution, warning, or danger. Ignoring this warning may lead to an accident. To reduce the risk of injury, fire, or electrocution, please always follow the recommendation shown below.
	This product is subject to the provision of European Directive 2012/19/EC. The symbol showing a wheeled bin crossed through indicates that the product requires separate refuse collection in the European Union. This applies to the product and all accessories marked with this symbol. Products marked as such may not be discarded with normal domestic waste, but must be taken to a collection point for recycling electrical and electronic devices.
	This device complies with Part 15 of the FCC Rules. Operation is subject to the following two conditions: (1) This device may not cause harmful interference, and (2) this device must accept any interference received, including interference that may cause undesired operation.

WARNING

1. Warnings must be followed carefully to avoid body injury. improper use may result in electric shock, fire, personal injury, and other damage:
 - 1) Keep unplugged when moving the machine.
 - 2) keep unplugged when installing accessories.
 - 3) Place on a flat and stable platform and operate under ventilated conditions.
 - 4) Wear special protective equipment when operating the machine.
 - 5) Do not use this machine in a hazardous location.
 - 6) Only use it when the machine is working correctly.
 - 7) Do not disassemble and repair this machine.
 - 8) Do not use an unsuitable AC outlet.
 - 9) Do not touch the heating plate when the machine heating
 - 10) Do not use in humid environments or in contact with water. Also, do not infiltrate liquid in the machine to prevent fire or electric shock caused by a short circuit.
 - 11) Do not use the power supply that does not meet the rated voltage. The power supply that does not meet the specified voltage may cause fire or electric shock.
 - 12) Ensure that the machine is grounded so as not to cause harm to body.
 - 13) Do not touch the rotating rod or bearing part with your fingers during use in case of injuries.
 - 14) If the machine is not in use for a long time, please unplug the power cord from the socket.
 - 15) Do not use the machine during thunderstorms or lightning to avoid damage to the machine.
 - 16) Place the machine smoothly on the flame-retardant table and keep away from flammable and explosive items.
 - 17) Please stop using it if the machine smokes, emits a peculiar smell, or becomes noisy and in other abnormal conditions.
 - 18) This appliance can be used by children aged 8 years and above and persons with reduced physical, sensory or mental capabilities or lack of experience and knowledge

if they have been given supervision or instruction concerning use of the appliance in a safe way and understand the hazards involved. Children shall not play with the appliance. Cleaning and user maintenance shall not be made by children without supervision

2, Type Y :If the supply cord is damaged, it must be replaced by the manufacturer, its service agent or similarly qualified persons in order to avoid a hazard.

3, In order to avoid a hazard due to inadvertent resetting of the thermal cutout, this appliance must not be supplied through an external switching device, such as a timer, or connected to a circuit that is regularly switched on and off by the utility.

INTRODUCTION

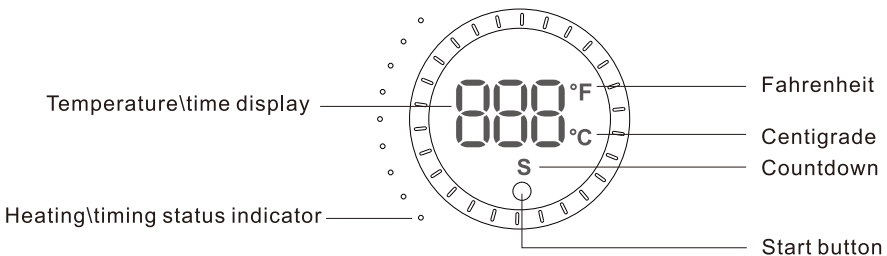
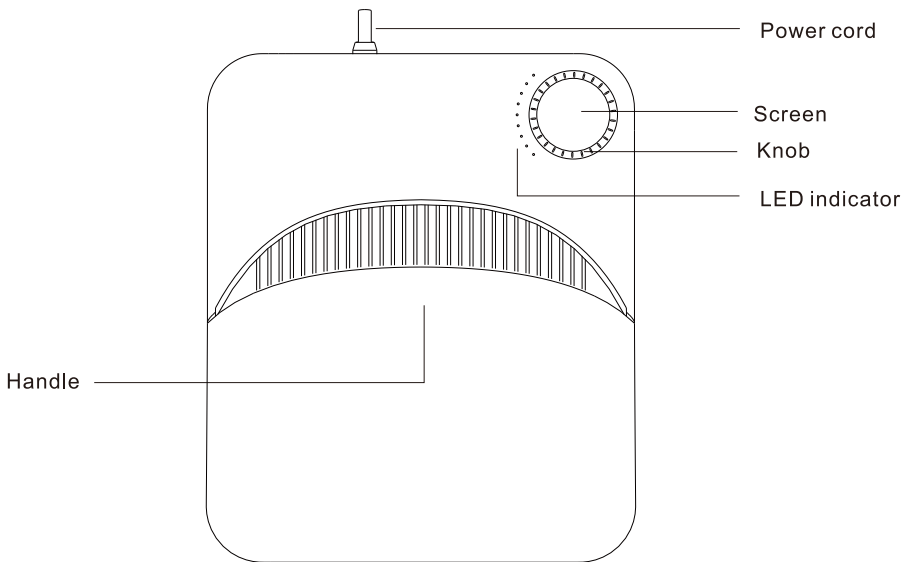

Accessories list

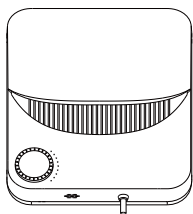

Main machine

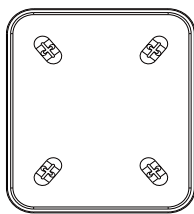

Insulated tray

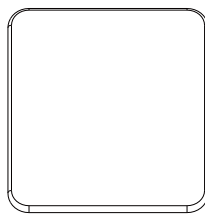

High temperature resistant table mat



User manual

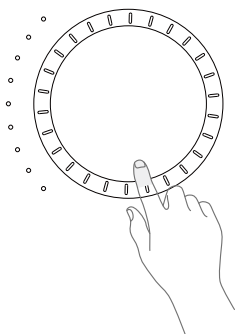

1.Startup

After power on, short press the start button to start the machine.
After startup, the machine will automatically heat up.

2.Shutdown

Press and hold the start button for 3s to shut down.

3.Auto shutdown

The machine will automatically shut down if there is no operation within 30min.

Temperature unit conversion °F ⇌ °C

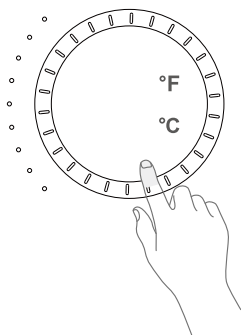

1. In shutdown state
2. Press and hold the start button for 6s.
3. Turn the switch to select the required temperature unit.
4. Short press the start button to start the machine.

Parameter setting

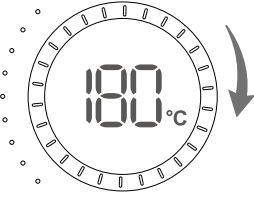

Temperature setting:

1. Turn the display half a turn to the right.
2. Enter the temperature setting mode after a beep sound.
3. Turn the switch to the right again to increase the temperature (+).
4. Turn the switch to the left again to reduce the temperature (-).

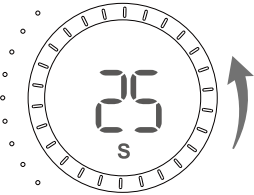

Time setting:

1. Turn the display half a turn to the left.
2. Enter the time setting mode after a beep sound.
3. Turn the switch to the right again to increase the time (+).
4. Turn the switch to the left again to reduce the time (-).

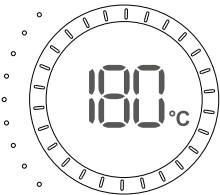

Ready to start

Parameter setting

1. Turn the display for a half turn.
2. Enter the setting mode after a beep sound.
3. Set corresponding parameters according to material type.

200°C 60 s

160°C 15 s

Heat transfer ink and paper

PET Heat transfer film

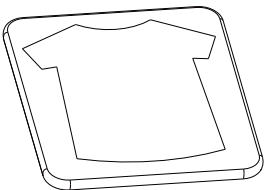

Start hot stamping

1. Place the T-shirt to be printed on the High temperature resistant table mat.
2. Print the T-shirt by hot stamping quickly and smoothly.
3. Place the pattern to be printed in place and fix it with High temperature resistant table mat.

Tips: Please pay attention to the front and back of the High temperature resistant table mat.

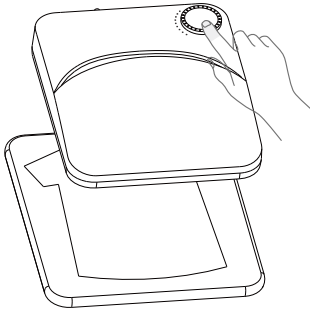

Hot stamping process

1. Make sure that the machine reaches the set temperature before transfer printing.
2. Grasp the handle of the machine and move it horizontally over the T-shirt.
3. Press the countdown button.
4. Press the machine with both hands and keep the pressure steady.
5. After the countdown, move away the machine.

Tips:

1. Increase the transfer time if the color of the transferred pattern is too light.
2. Reduce the transfer time if the color of the transferred pattern is too dark.

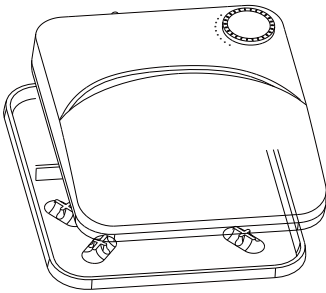

Hot stamping completed

After the printing, put the machine on the insulation plate.

Attention

1. The insulation plate must be stable.
2. Do not place inflammables around the insulation plate.

Electrical Diagram

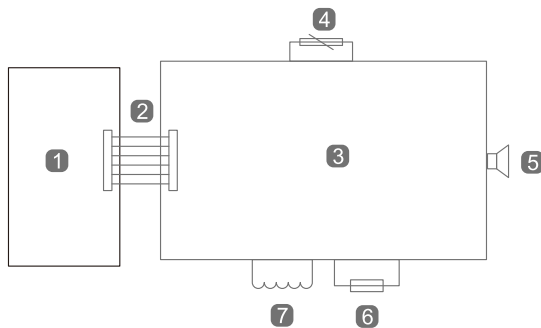

- 1** Main Control Board **2** Connect the cable **3** Power Strip
- 4** Down temperature sensor **5** Buzzer
- 6** Thermal cutoff **7** Heating Filament

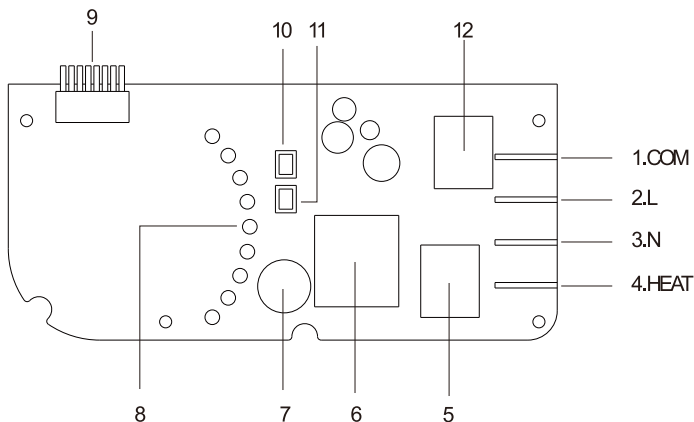

1. Output COM 2. Input L 3. Input N 4. Output HEAT
 5. Relay (a) 6. Thyristor 7. Buzzer 8. Status indicator
 9. Connecting cable 10. Spare plug 11. NTC bottom temperature sensor
 12. Relay (b)

PRODUCT PARAMETERS

Name: heat press machine

Heating method: Mica heat

Rated voltage/frequency: 220-240V~ 50Hz 750W For European users

Rated voltage/frequency: 120V~ 60Hz 810W For US users

Temperature range: 40°C-205°C(104°F-401°F) Time range: 1-999s

Model: F1210

Heating plate size: 245×297MM

WARRANTY

Type	Items	Period
Whole machine	Parts of machine (excl. accessories)	1 year

COMMON FAULT ANALYSIS

Fault phenomenon	Faults Causes and Solutions
Machine temperature does not rise	1.The motherboard and the motor link line off. 2.The main board has no current output (the main board does not supply power to the toast coaster).Replace the motherboard.
Display error	F1: The temperature sensing probe is faulty. Power-on does not show, check that the power cord is tightly connected to the socket.

Manufacturer:Yiwu Sunmeta Technology. Co., Ltd
 Address: NO.5 Xinpan Road, Shangxi Toen, Yiwu City, Zhejiang province, China

UK Importer: FREE MOOD LTD

Address: 2 Holywell Lane, London, England, EC2A 3ET

EU Importer: WAITCHX

Address: 250 bis boulevard Saint-Germain 75007 Paris



EUREP UK LTD
 UNIT2264,100 OCK STREET,ABINGDON
 OXFORDSHIRE ENGLAND OX14 5DH



EUREP GmbH
 Unterlettenweg 1a, 85051 Ingolstadt, Germany

Made in China

VEVOR[®]

E-mail: CustomerService@vevor.com