

VEVOR[®]

**DRYWALL STILTS
USER MANUAL**

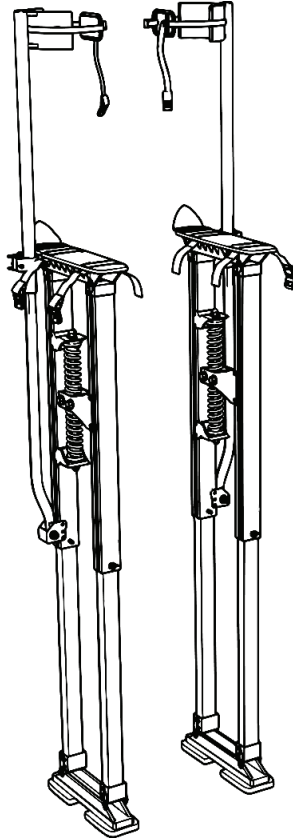

NEED HELP? CONTACT US!

Have product questions? Need technical support? Please feel free to contact us:



CustomerService@vevor.com

This is the original instruction. Please read all manual instructions carefully before operating. VEVOR reserves a clear interpretation of our user manual. The appearance of the product shall be subject to the product you received. Please forgive us that we won't inform you again if there are any technology or software updates on our product.



Safety Instructions

1. Inspect the stilts thoroughly before use. Ensure that the parts are free of damage and that all the bolts and screws are fully tightened enough.
2. Use this product only on level and flat ground surfaces and there is no low profile furniture and other obstructions around.
3. When adjusting the height of the stilts, take them off your legs first for safety concerns.
4. Keep all straps fastened and secured before you walk on the stilts.
5. When walking on the stilts, never take a big step. Instead, make sure the stilts are raised well above the ground with each step.
6. Never use the stilts to walk on a slippery ground.
7. Never overload the stilts.
8. Walk slowly. Don't run or walk fast on the stilts.
9. Don't modify the stilts arbitrarily.
10. Don't walk on the stilts if you are influenced by alcohol or drugs.
11. Children are not allowed to use this product. Minors and seniors are not recommended to use this product.
12. Ensure the surrounding area is clean when using this product. Always wear protective gear (especially for the knee and elbow) and a helmet before using the product. It's recommended that the beginner uses two supporting sticks for balance.
13. It is forbidden to use this product on public roads or streets.
14. When using the product, it is recommended to wear anti-slip shoes.
15. The intended purpose of this product is for architectural decoration or ceiling repair. It is not for entertaining or dancing.
16. It's recommended to let the other 2 people assist the user stand on the stilts.

PACKAGE CONTENT

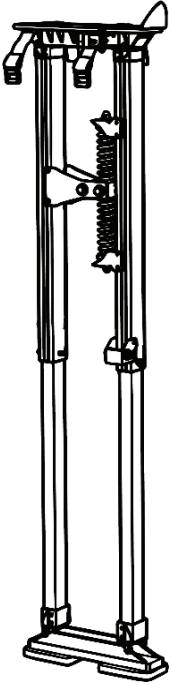

Skid-proof Rubber Sole x 2

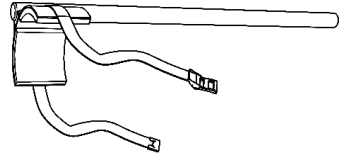

Metal Buckle x 2

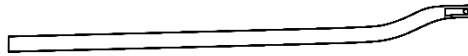

Supporting Stick x 2

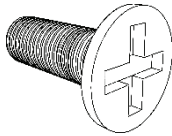

Bolt x 4

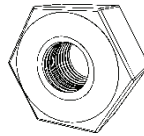

Nut x 4

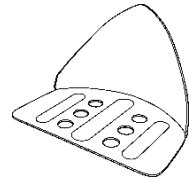

3-Position Heel Bracket x 2

SPECIFICATIONS

Model Series	HCST-24SI	HCST-24BK
Overall Dimensions (L x W x H)	36.2" x 11" x 5.5" (920×280×140mm)	36.2" x 11" x 5.5" (920×280×140mm)
Weight Capacity	225 lbs (102 kg)	225 lbs (102 kg)
Adjustable Height	24" to 40" (610 to 1016mm)	24" to 40" (610 to 1016mm)

ASSEMBLY INSTRUCTIONS

The assembly procedures of the two stilts are the same. Here we take one stilt as an example. You can follow the same steps to finish the assembly for the other stilt.

1

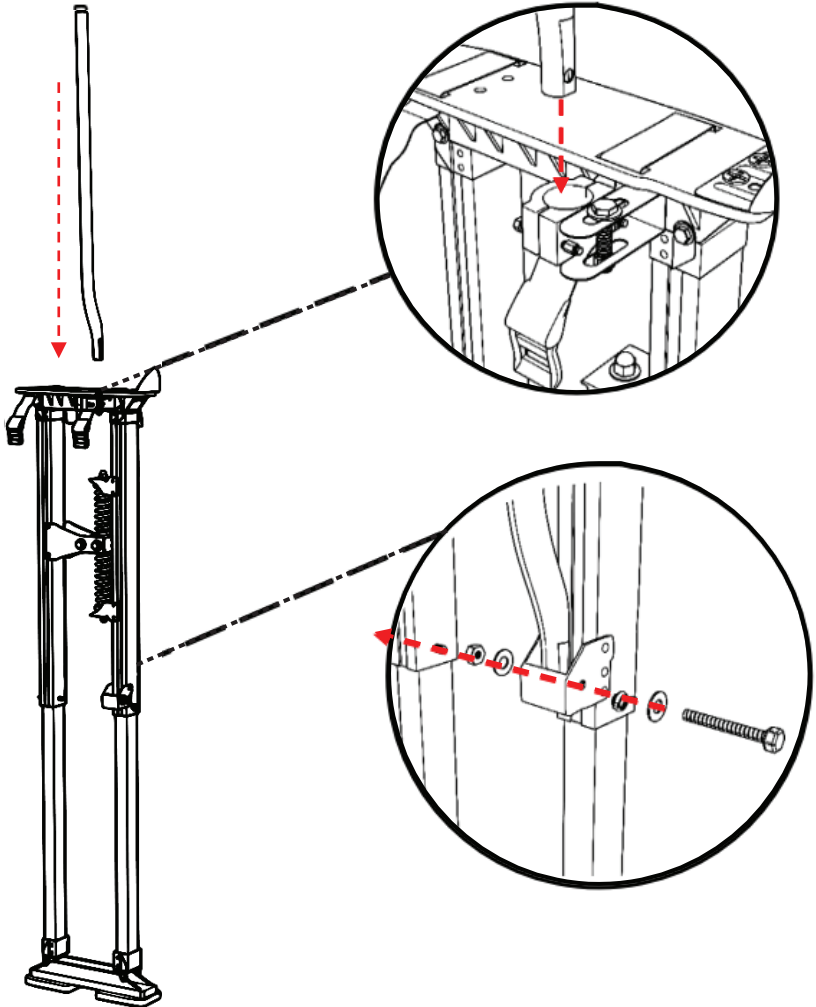

1. Insert the supporting stick through the side hole on the left stilt.
2. Secure the end of the supporting stick on the side bracket of the left stilt with the bolt and nut.
(The bolt and nut are preinstalled on the side bracket.)

2

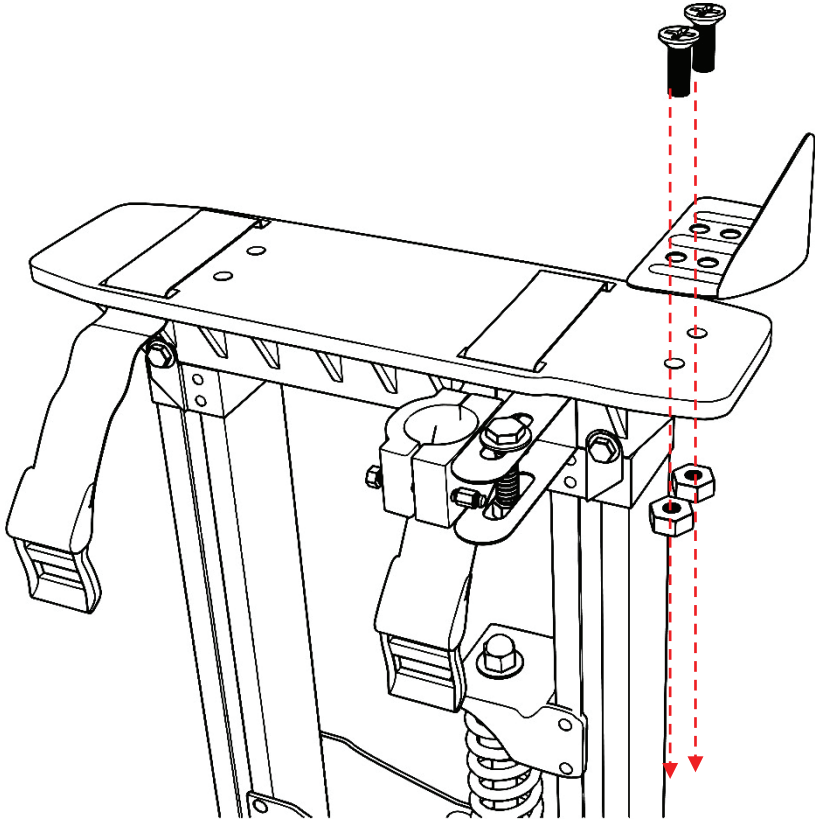

Install the 3-position heel bracket on the top of the stilt with two bolts and two nuts.

3

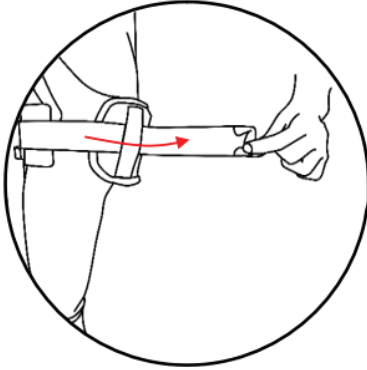

Thread the ends of the strap through the skid-proof rubber sole.



Thread the end of the strap through their buckles.

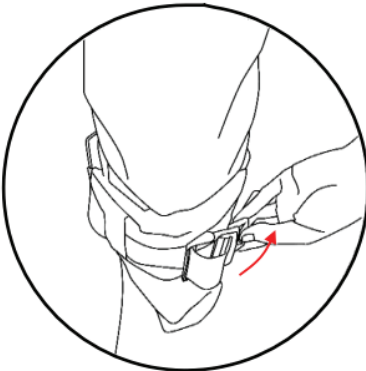
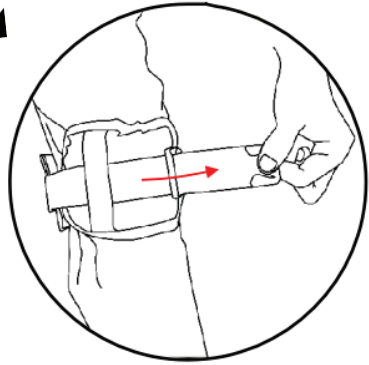

Fasten up the strap.

Ensure that the strap is fastened tightly and then the preparation is finished.

2

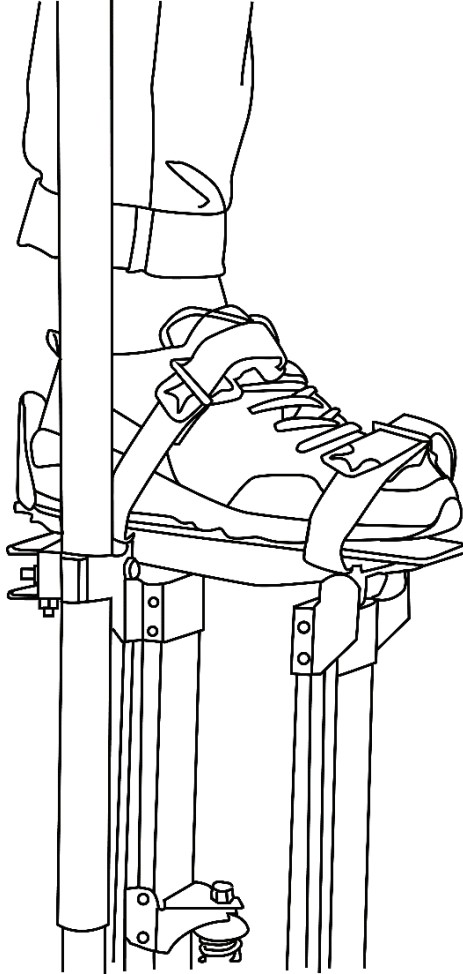

Use the straps on the stilt to secure your feet. Ensure that the straps are fastened tightly.

ADJUST THE STILT HEIGHT

NOTE:

Before adjusting the height of the stilts, take your feet off the stilts first.

1

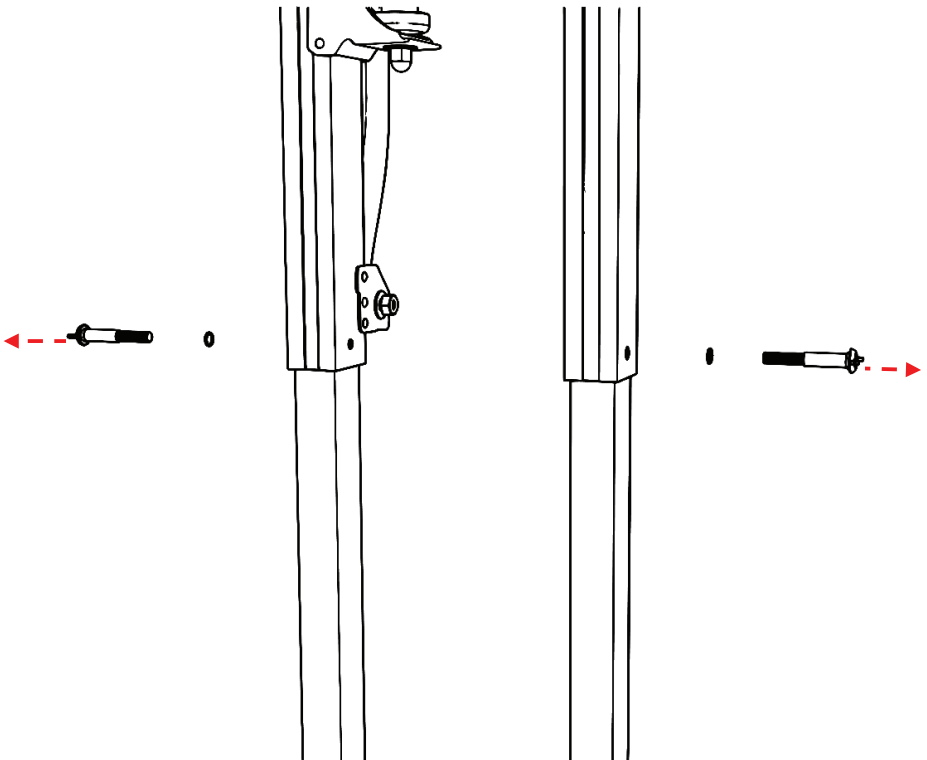

Loosen and separate the 4 bolts on the stilts.

2

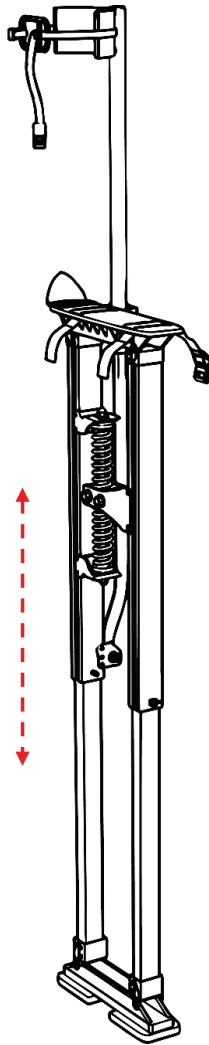

Adjust the height of the stilts. Ensure that the heights of both stilts are the same. After that, fasten the bolts.

Importer: WAITCHX

Address: 250 bis boulevard Saint-Germain 75007 Paris

Importer: FREE MOOD LTD

Address: 2 Holywell Lane, London, England, EC2A 3ET

Manufacturer: Suzhou Hongcai Exhibition Equipment Co.,Ltd.

Address: No.429, Caifu Road, Cailian, Linhu Town, Wuzhong District, Suzhou, China

Made in China

VEVOR[®]

E-mail: CustomerService@vevor.com