

# SLUSH MACHINE MANUAL

Please read carefully before using the slush machine

---

## Contents

1. introduction .....	2	6.4 Starting a 3-bowl slush machine.....	6
1.1 Manufacturer .....	2	6.5 Dispensing the slush.....	6
1.2 Operator .....	2	6.6 Emergency.....	6
1.3 Manual distribution .....	2	<b>7. Cleaning and maintenance .....</b>	<b>6-10</b>
1.3.1 Function and content .....	2	7.1 Empty Bowl .....	6
1.3.2 Who to read manual .....	2	7.2 Disassembling the dispensing tap..	7
1.3.3 How to keep manual .....	2	7.3 Moving out bowl and cover .....	7
<b>2. Machine description .....</b>	<b>2-3</b>	7.4 Cleaning and disinfecting parts ....	7
2.1 Usage .....	2	7.5 Reset cleaned parts .....	8
2.2 Main components .....	2	7.6 Cleaning step .....	9
2.3 Technical data .....	3	7.7 Cleaning drip tray .....	9
2.4 ControlPanel .....	3	7.8 Replacing bulb .....	9
<b>3. Safety manual .....</b>	<b>4</b>	7.9 Cleaning condenser .....	9
<b>4. Transportation and storage. ....</b>	<b>4</b>	7.9.1 Cleaning condenser of one-bowl slush machine.....	10
4.1 Packing .....	4	7.9.2 Cleaning condenser of two-bowl slush machine.....	10
4.2 Transportation .....	4	7.10 Scheduled maintenance .....	10
4.3 Storage .....	4	<b>8. Waste treatment. ....</b>	<b>10</b>
<b>5. Installation .....</b>	<b>4-5</b>	<b>9. Troubleshooting .....</b>	<b>11</b>
5.1 Parts list .....	4	9.1 Fault Codes and Solutions For Slush Machine .....	12-13
5.2 Position to install .....	4	<b>10. Intelligent electronic valves system</b> .....	<b>14</b>
5.3 Handling package material .....	5	<b>11. Slush machine Explosive diagram</b> .....	<b>15-16</b>
5.4 Connect power .....	5		
<b>6. Operation .....</b>	<b>5-6</b>		
6.1 Preparing material .....	5		
6.2 Starting a 1-bowl slush machine.....	5		
6.3 Starting a 2-bowl slush machine.....	5		

## 1.Introduction

### 1.1 Manufacturer

The manufacturer's details are shown on the identification plate

### 1.2 Operator

Based on different applications, there are two types of persons.

## User

In accord with Health standard people trained complete techniques,  
 Know all to distribute slush have below ability after reading this manual  
 Place and change slush machine  
 Properly dispensing the products  
 Cleaning the slush machine

Specialized technical people  
 Studied this manual and trained how to install, use and maintain this slush machine;  
 When serious fault, can repair the slush machine and know this manual well;  
 Master all information of the manual and can explain the diagrams and graphs correctly;  
 Know important hygienic knowledge well, prevent accident occurring, know technical and safety standard  
 Have experience to serve this kind of slush machine.  
 Master treatment measure to emergency, find separated safety device and use the machine correctly



People are banned to use the machine who do not accord with above requirement

### 1.3 Manual distribution

Users have to read this manual carefully before using.

#### 1.3.1 Function and content

Offer vital information of using and installing

#### 1.3.2 Who to read manual

Users and specialized technical people.

This manual is an inseparable part of the machine.  
 So it needs to be delivered to the purchaser when sold.

#### 1.3.3 How to keep manual

Manual has to be placed nearby the machine and keep intact and clear

## 2. Machine description

### 2.1 Usage

This machine is specially used for making slush. If used to make dairy and other foods, bowl material temperature needs to be tested and abide by the machine's current regulation and standard

### 2.2 Main Component

- |                    |                |
|--------------------|----------------|
| 1 Bowl roof        | 6 Drain hose   |
| 2 Bowl             | 7 Tap          |
| 3 Control panel    | 8 Handle       |
| 4 Water tray       | 9 Machine foot |
| 5 Water tray cover |                |

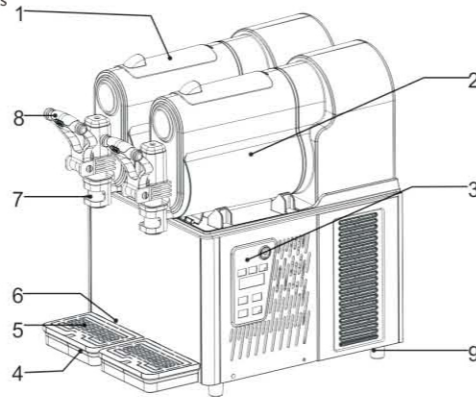

In this manual, the items mean as below

- XRJ3LX1, one-bowl slush machine
- XRJ3LX2, two-bowl slush machine
- XRJ3LX3, three-bowl slush machine

## 2.3 Technical data

Remarks:  
 Capacity and weight are approximate number

Mode	XRJ3LX1	XRJ3LX2	XRJ3LX3
Size LxDxH-(cm)	20X50X52	35X50X52	52X50X52
Gross weight (kg) (Bowl empty)	18	29	40
Power (w) Input (w)	See nameplate		
Temperature	Min, 20°C/68°F Max, 32°C/89.6°F		
Bowl	1	2	3
Bowl (L)	3	6	9
Noise	<<70dB		
Climate type	N		



Manufactory has right to change and will not notice specially.



Any change or increase has to be approved and executed by Manufactory..

Fig.2

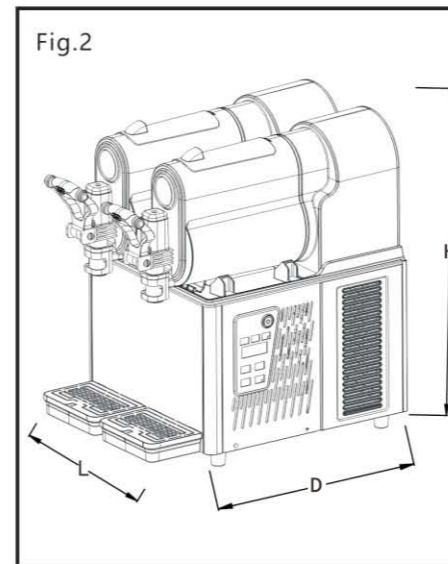

## 2.4 Control panel

Fig.3



Switch on/off

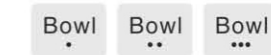

Bowl Button



Display screen



Slush hardness



Slush softness

LIGHT



Light

SET



Shift ( slush system/cleaning system/Standby system)

### 3.Safety manual

Slush machine parts and condenser's installation, slush machine troubleshooting, exclusion and maintenance have to be operated by manufacturer professionals or people who have related experience. Without experienced people monitoring or guiding, slush machine can not be used by disabled, sense disable, mental disable people's, lack of experience and knowledge

Children need to be taken care when playing nearby the machine.

When machine's wire broken, they have to be replaced by manufacturer professionals or people who have related experience.

When machine scraped, it has to be delivered and handled by related authority institution

### 4.Transportation and storage

#### 4.1 Packing

Carton box, contoured foam & collect.

Packing size (approximate)

	Width (L)	Depth (D)	Hight (H)	Weight
XRJ3LX1	270mm	570mm	570mm	27kg
XRJ3LX2	430mm	570mm	570mm	39kg
XRJ3LX3	590mm	570mm	570mm	52kg

图4

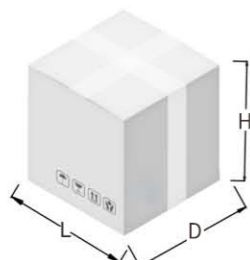

Remarks: packing size and weight are approximate.

#### 4.2.Transportation

Keep upward and carried by two people at least.

#### 4.3Storage

Notice:please do not exceed three layers.

Fig.5



### 5.Installation

The slush machine has to be installed indoor with hard and plain ground under enough light and ventilation (Ground inclination can't be more than 2 degree)

#### 5.1Parts list

After cleaning and disinfecting all indicated parts in manual have to be coated with lubricating oil.

#### 5.2Position to install

Installation position have to planed in advance;  
Installation place have to be hard and plain  
Installation condition is enough light and ventilation and clean;  
Power socket is also needed;  
Installation distance from other objects see below fig.6

Fig.6

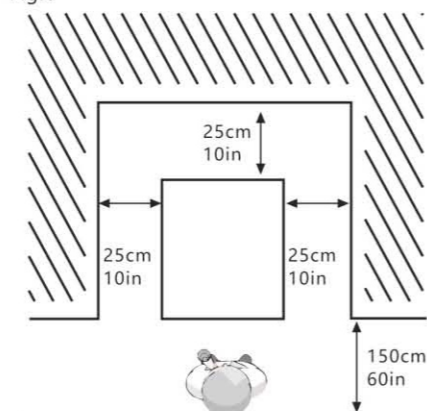

### 5.3 Handling package material

Handling packing material separately under local rules and we suggest keep it to repack and ship in future.

#### 5.4Connect power

Ensure slush machine is off before connecting power.

Then plug in to connect power.

Data can be referred from machine back nameplate.

Warning: Socket has to be placed within user touching distance in order to unplug quickly when emergency without using other tools.

### 6.Operation

#### 6.1 Preparing material and stirring evenly

Only water is prohibited



Fig.7

Attention

Operate under manufactory direction;  
Dilute and stir concentrated liquor with water in a container  
Mixture sugar content should be within 10%-15%  
lower content will damage the augers and gear motors

Remove the lid as below steps

- 1、Lift the top lid;
- 2、Pour the material into bowls



Warning:

Hot liquid can not be put in(hot liquid means degree exceed 25 °C)

Material level can not exceed maximum height level

3.Close the top lid after pouring the material



Warning :Before connecting power or starting machine, put material into bowl





Material can not just be water.





Warning:Banning putting hand in bowl when machine is working





#### 6.2 Starting a 1-BOWL SLUSH MACHINE

The following controls are on the panel:

A. Main switch  :It is used to switch on/off the power supply to the whole machine.

B. Light Switch  : It is used to switch on/off the light

C. SET switch  : It is used to shift 3 different modes. Press  , display shows SLS that is used to switch on Slush Mode . Press  again, display shows CLR that is used to switch on Cleaning Mode. Press  once more, display shows OFF that is used to switch off Mixing .







D. Slush hardness  and Slush softness  Switch : They are used to adjust slush thickness , in slush model ,display shows SLS, then press  up or down  to increase or reduce the slush thickness





#### 6.3 Starting a 2-BOWL SLUSH MACHINE

The following controls are on the panel:

A. Main switch  :It is used to switch on/off the power supply to the whole machine.

B. Light Switch  : It is used to switch on/off the light

C. SET switch  : It is used to shift 3 different modes. Firstly Press corresponding bowl1  or bowl2  , then press  , display shows SLS that is used to switch on Slush Mode . Press  again, display shows CLR that is used to switch on Cleaning Mode. Press  once more, display shows OFF that is used to switch off Mixing .

D. Slush hardness and Slush softness Switch : They are used to adjust slush thickness , in slush model , press corresponding bowl1  or bowl2  , then press  up or  down to increase or reduce the slush thickness.





## 6.4 Starting a 3-BOWL SLUSH MACHINE

The following controls are on the panel:







A. Main switch : It is used to switch on/off the power supply to the whole machine.

B. Light Switch : It is used to switch on/off the light

C. SET switch : It is used to shift 3 different modes.

Firstly press corresponding bowl1 , bowl2  or bowl3 , then press , display shows SLS that is used to switch on Slush Mode. Press  again, display shows CLR that is used to switch on Cleaning Mode.

Press  once more, display shows OFF that is used to switch off Mixing.

D. Slush hardness  and Slush softness  Switch: They are used to adjust slush thickness, in slush model, press corresponding bowl1 , bowl2  or bowl3 , then press  up or  down to increase or reduce the slush thickness.

## 6.5 Dispensing slush

Pull down the handle and slush will outflow from the bowl

 Attention: if distribute slush first time or after a long stop, please extrude and waste a little and then distribute customers.

 Attention: Material temperature in bowl needs to be tested with Standard thermometer timely to ensure material temperature is lower than storing temperature. Power can not be cut off when machine is working or there are material.

## 6.5 Emergency

 Warning: When emergency, machine needs to be turned off by power button and cut off power

If frozen, cut off power and ask for specialized people to handle. If fire, clear nearby area and ask for professionals.

## 7. Cleaning and maintenance

 Before cleaning or maintaining external parts, please ensure main switch is off and unplug.

Any cleaning or maintaining protection supplies needs to wear (gloves, glasses and so on) based on local safety standard

- When cleaning or maintaining, operate as below.
- Wear protective gloves against an accident.
- Do not use solvent or flammable substance
- Do not use tough or metal sponge to clean machine or parts
- Do not spray liquid to nearby area.
- Do not wash parts in the bowl.
- Do not dry parts in furnace or microwave oven.
- Do not immerse the machine in water
- Do not spray the water to the machine directly.
- Warm water and approximate cleaner can be used (abiding by local law and rules)
- After finishing, make sure that all protective covers and guards that have been removed or opened and sent back in place and properly secured.

Cleanliness and hygiene have to be taken carefully and forcibly based on local standard to ensure qualified slush

 Cleanliness and hygiene have to be taken carefully and forcibly based on local standard to ensure qualified slush Bowl needs to be cleaned everyday at least and abiding by local laws and regulations And cleaning times may be added based on different products More information, please consult manufactories. if machine will not be used one day continuously please clean distributing taps with clean rag.

Even though machine's components stainless steel, plastic and rubber are easy to clean as well as its shape, it is still necessary to prevent germs and fungi reproduction due to halfway cleaning When the plug is not pulled out or the total switch is in the open state, do not clean or maintenance the machine.

## 7.1 Empty Bowl

Before cleaning bowl, empty bowl If it is the first time to use, no need to make it empty. This manual just explains one bowl as sample Other bowls' operations are the same based on related their buttons. Please set the bowl to "clean state", then pour material from bowl.

## 7.2 Disassembling the dispensing tap

Before removing the bowl, it is recommended to disassemble the tap, after cleaning, the tap must not be reapplied until the bowl has been correctly positioned in its seat. Remove fastener with a screwdriver, then disconnect the dispensing handle by pushing upward, then push the piston and spring downward, remove the O-ring. Put all spare parts in lukewarm water (water temperature around 50°C) and clean as fig. 9

fig.8

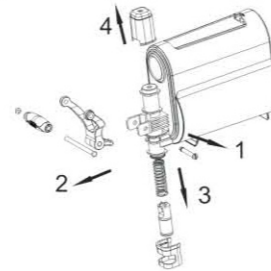

fig.9



Do not disassemble taps when there are products or liquid in bowls.

## 7.3 Move out bowl and cover

Move out every bowl to clean the machine. Move out the bowl as below steps:

1. Lift the top cover upward and take it out. Pull the tank upward and outward to completely remove it from its seat.
2. Screwing off the nut.
3. Take out the stirrer and the seal of stirrer.

See Fig.10.

fig.10

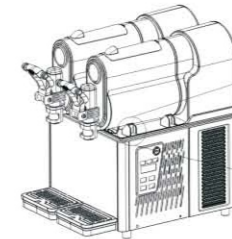

## 7.4 Clean and disinfect parts

All dismantled parts should be cleaned thoroughly

 Importance: Cleaning way has to abide by local current hygiene standard..

Please operate as below instructions:  
Pour water in the container. mix sanitizer with water (Add 2% sodium hypochlorite to water)  
Sponge with sanitizer clean bowl, cover and evaporator thoroughly  
Clean with water thoroughly  
Add sanitizer to another container.  
Put dismantled parts in sanitizer 30 minutes.  
Re clean with water thoroughly.  
Make the parts dry.  
Assemble machine under 7.5 instruction.  
Sponge with sanitizer clean the roof and the parts touching the raw material.

fig.11

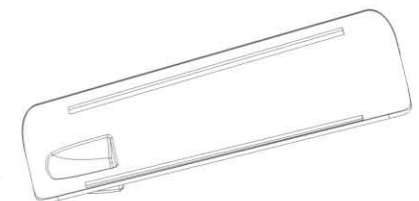

Retain 30 minutes

Clean bottom surface with water 2-3 times by the sponge.  
Put the cover at clean area and dry it by rag  
Ban cleaning by water or disinfecting before taking away the cover

## 7.5 Reset cleaned parts

All disinfected parts have to be reassembled carefully. some parts need to be lubricated to work normally. Put gasket(A) on stirrer.see Fig.12

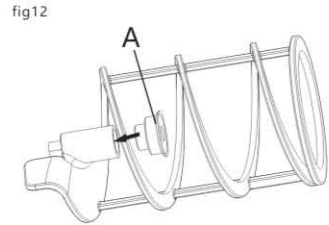

Importance: Check gasket in regular if broken. Please replace new one. Replace gasket(A) once at least one year

Using the Vaseline provided, lubricate the seal A) see Fig.13

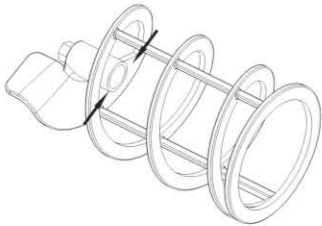

Install seal (B),lubricate the entire surface with Vaseline as arrow marks,see Fig.14

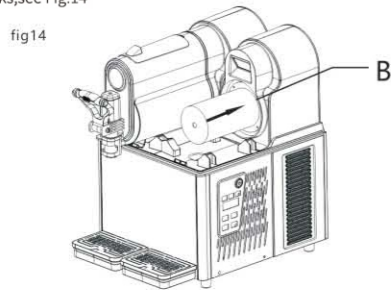

Put stirrer into the tank as Fig.14.

Attention: Adjust the stirrer to appropriate location.

See fig.14-1

Replace the seal ring. When the motor part leaks, you need to replace the seal ring Take out the motor bracket connected to the motor and then replace the head seal ring (washer of axis, seal of axis).When replacing. You need to add some Vaseline Then install the motor bracket connected to the motor.

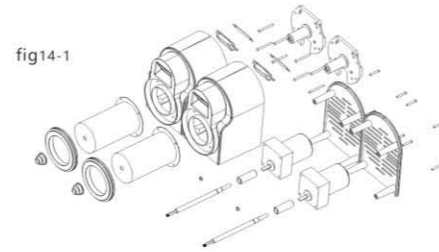

Fixed the stirrer and install the cover as Fig.15

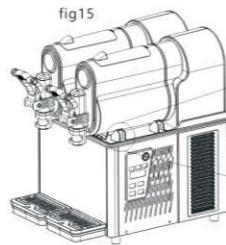

Attention: Adjust the cover to appropriate location.

Install the roof as Fig 16

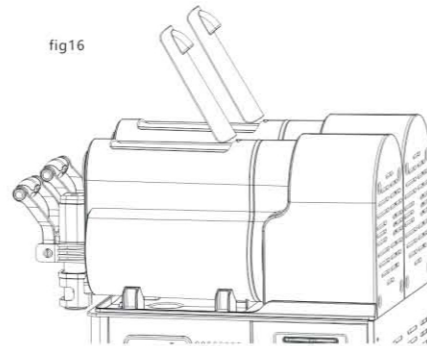

Press down top roof until its joint fit in with motor base.

Install taps as below instructions as Fig.17

1. Lubricate bolt totally with vaseline.
2. Insert screw when taps are steady.

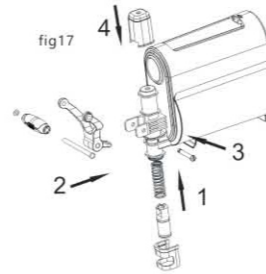

Attention:Install all parts under figures instructions.If not lubricate with vaseline well,material may permeate

## 7.6 Clean step

Before using this machine, below cleaning steps are needed

1. Fill bowl with water fully
2. Start machine only in cleaning mode and stir for 5 minute
3. Stop machine and open tap to clear container.

## 7.7 Cleaning drip tray

Drip tray should be emptied and cleaned everyday

Attention: All machine drip trays should be cleaned. drip tray need to be emptied and cleaned. Take out drip tray by lifting from top.

Wash the tray and grid separately with lukewarm water.Dry all Of the components.Fit the tray back in place and press down to secure it to the machine.Reposition the grid on top of the tray

When machines stopped ,clean by wet rag and dry the parts.

## 7.8 Replace bulb

Only when machine power is off and unplugged bulb can be replaced

According to below figure, open the small back panel, replace the LED bulb, after assembled put the panel back, confirm closed well.

fig19

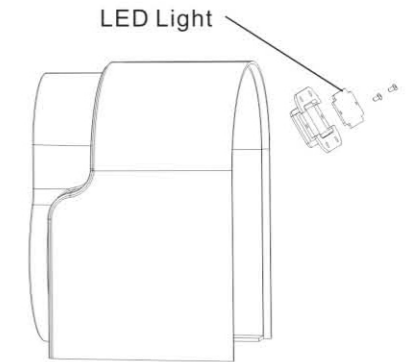

## 7.9 Clean condenser

Only professionals can clean condenser .They know all operating steps well using approximate device and abide by local law and regulation strictly

Condenser needs to be cleaned in regular.

Warning: Machine sharp surface may reveal after dismantling safety protection parts. Dirty condenser will weaken machine function. Condenser can be seen after taking out safety protection parts. Even though only one plate (front or back or side) is not installed the machine is also banned to use. Operators are banned to clean condenser

Protection parts need to be positioned by Screwdrivers

### 7.9. Cleaning condenser of one-bowl slush machine

Safety protection parts need screwdrivers to fasten and dismantle.

1. Loose side panel screw.
2. Take out side panel
3. Dismantle safety protection parts. Brush dust from condenser surface with dry brush as Fig21

Fig.21

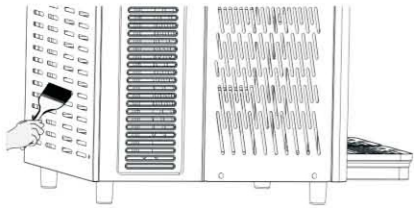

After cleaning condenser, reposition safety protection parts

### 7.9.2 Cleaning condenser of two-bowl slush machine

According to the following instructions

1. Loose 3 screws of the back plate.
2. Loose 5 screws of the side plate.
3. Take out the side panel.

Dismantle safety protection parts.

Brush dust from condenser surface with dry brush as below.

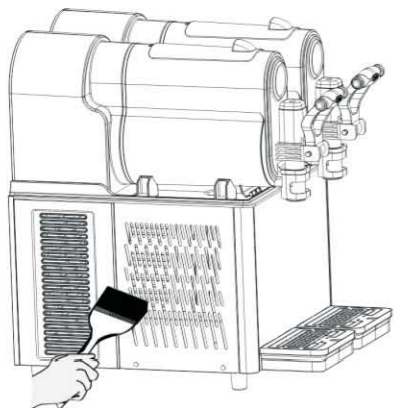

### 7.10 Scheduled maintenance

This machine needs to be maintained by professionals in regular (at least 1 year).

Regular maintenance can ensure machine and its parts in good safety state

Any broken parts need to be replaced with original manufacturer

When any parts of machine are malfunctioned or broken machine is banned to use.

The user can not maintain the machine himself

### 8. Waste treatment

Electronic waste need to be handled according to 2002/96/EC  
But wastes need to be dismantled and classified  
and useful parts should be recycled



Above rubbish bin reminds people classifying rubbish.

Treating wastes correctly will protect our environment.

## 9. Troubleshooting

Trouble	Potential problems	Solution
Can not turn on the machine	No input power	Insert the plug into the appropriate socket
	Not pressed the switch	Press the switch
Outlet leaking	Outlet without vaseline	Add vaseline on outlet
	Outlet broken	Change the outlet
Bowl leaking	The bowl not be installed in suitable position	Check the bowl position
	No vaseline on bowl's seal ring	Add vaseline on seal ring
	Bad seal ring	Change the seal ring
The stirrer not working	Not turn on the main switch	Turn on the main switch
	Bowl inside freezing	Turn off the main switch and let the ice melting
The machine not making slush	Not turn on the main switch	Turn on the main switch
	Not turn to the "SLS" mode	Turn to the "SLS" mode"
	The slush thickness is not suitable	Adjust the slush thickness
	Condenser too dirty/ poor ventilation	Clean the condenser
	Slush machine approach to the hot position	Put the machine in a cool position
The stirrer makes noisy	Stirrer's seal ring installation badly	Check and replace the seal ring
	No vaseline on seal ring or seal ring broken	Add vaseline or change the seal ring
No slush coming out from the outlet	Bowl inside freezing melting	Turn off the main switch and let the ice

## 9.1 Fault Codes and Solutions For Slush Machine

### 9.1.1. When the temperature sensor is not connected,"LL" is displayed

Check whether the temperature sensor is installed well. or the connecting wire is damaged or broken, replace the temperature sensor.

### 9.1.2 The temperature sensor is short-circuited and it displays "LL"

Check whether the temperature sensor is installed properly, or the connecting wires are damaged and connected together, or the temperature measured by the temperature sensor exceeds 60°C replace the temperature sensor.

### 9.1.3 When the grid voltage is too high, the machine stops working and generates an alarm code "UH"

### 9.1.4. When the grid voltage is too low, the machine stops working and generates an alarm code "UL"

1: it is recommended that customers buy a voltage stabilizer, so that the voltage can be used within a reasonable range

2: Change the voltage alarm parameters without generating voltage alarm

I. In the power-on state, long press the "Settings" button for 3 seconds to enter the setting menu, and the window flashes as



II. Then click the "Settings" button, the window flashes as



III. Then click the "Slush softness" button to set the value to 0

IV. Wait until the display does not flash, indicating that the setting is successful

### 9.1.5. The measured motor current is too high, the current channel generates an alarm and protects the shutdown, the display code is SLS Err

1: If the mixing shaft is blocked and the shutdown protection is caused, it will automatically restart after 5 minutes

2: If the motor is broken and rotates very slowly or cannot rotate, you need to replace a new motor

3: Or change the motor current alarm parameters and stop if no alarm is generated, and then check whether the motor is rotating

I. In the working state, long press the "Setting" button for 3 seconds to enter the setting menu, the window flashes as

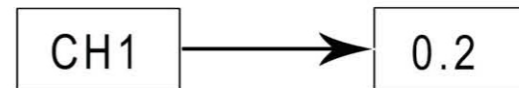

II. Then click the "Setting" button, the window flashes as



III. Then click the "Setting" button, the window flashes as

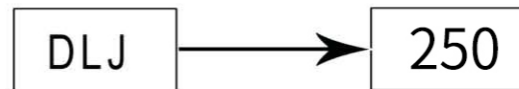

IV. Then click the "slush softness" button to set the value to 0

V. Wait until the display does not flash, indicating that the setting is successful



## 10. Intelligent electronic valve system

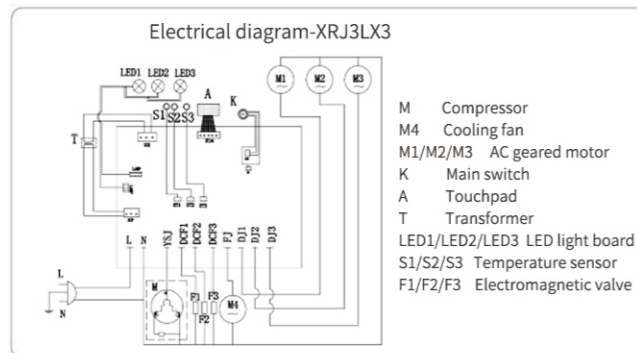
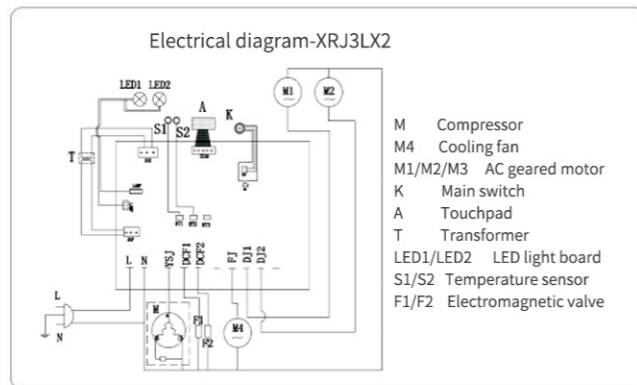
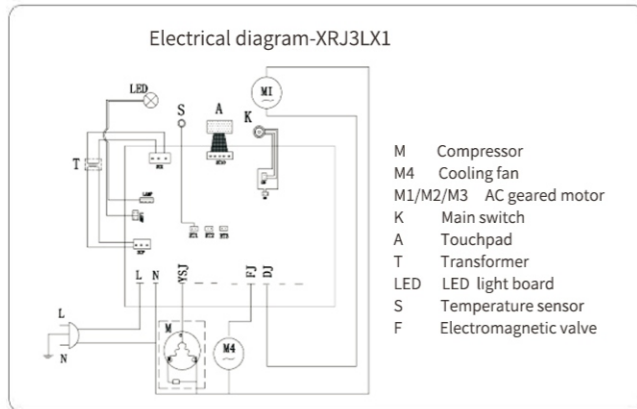

## 11. Slush machine explosive diagram

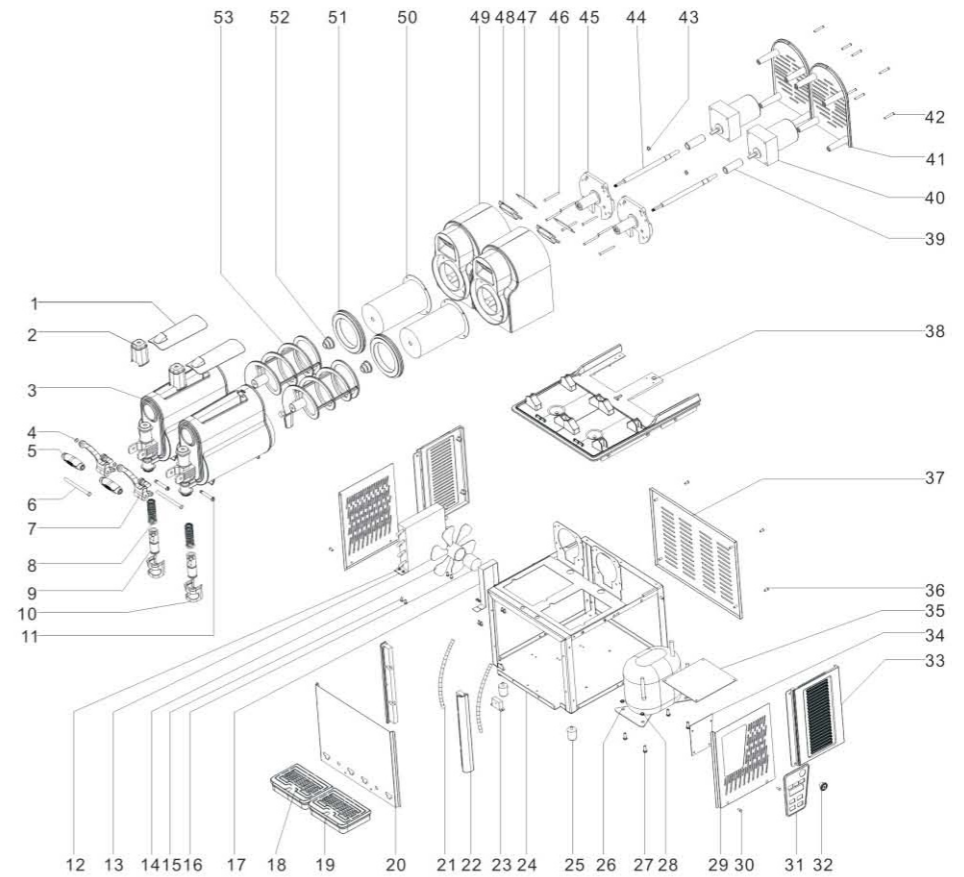

Code	Parts name
1	Roof
2	The roof for handle
3	Lank
4	The main Pin of the handlo
5	Handle
6	Pin of the handle
7	Wrench bracket
8	Spring
9	Plunger
10	The cover of handle
11	Vice-Pin of the handle
12	Hex nut
13	Condenser
14	Fan
15	The fixed bolt for fan motor
16	Fan motor
17	The holder for fan motor
18	The roof of Water tray
19	Drip tray
20	Front panel
21	Pipe
22	Jambe
23	Transformer
24	Main body frame
25	Rubber fool
26	Compressor
27	The screw of compressor
28	The Nut of compressor

Code	Parts name
29	Panel
30	Side plate fixing screw
31	Control panel
32	Switch
33	Back panel
34	pcb board
35	Mainboard
36	Plate nut
37	Backboard
38	Base panel for 2 tank
39	Copper bush
40	Motor
41	The back panel for motor
42	Back mounting screw
43	Spring
44	Stirring Rods
45	The holder of motor
46	Motor fixed screw
47	The main board for light
48	Lamp shade
49	The holder for stirrer
50	Evaporator
51	Tank seal ring
52	Seal of mixing auger
53	Mixing auger
54	
55	
56	