

VEVOR[®]

TOUGH TOOLS, HALF PRICE

Technical Support and E-Warranty Certificate www.vevor.com/support

ELECTRIC WINCH

MODEL:P2000-1/P3000-1C/P4000-1D/P4000-1W

We continue to be committed to provide you tools with competitive price.

"Save Half", "Half Price" or any other similar expressions used by us only represents an estimate of savings you might benefit from buying certain tools with us compared to the major top brands and does not necessarily mean to cover all categories of tools offered by us. You are kindly reminded to verify carefully when you are placing an order with us if you are actually saving half in comparison with the top major brands.

VEVOR®

TOUGH TOOLS, HALF PRICE

ELECTRIC WINCH

MODEL: P2000-1/P3000-1C/P4000-1D/P4000-1W



NEED HELP? CONTACT US!

Have product questions? Need technical support? Please feel free to contact us:

 CustomerService@vevor.com

This is the original instruction, please read all manual instructions carefully before operating. VEVOR reserves a clear interpretation of our user manual. The appearance of the product shall be subject to the product you received. Please forgive us that we won't inform you again if there are any technology or software updates on our product.

SAFE INSTRUCTIONS

! WARNING: Read carefully and understand all ASSEMBLY AND OPERATION INSTRUCTIONS before operating. Failure to follow the safety rules and other basic safety precautions may result in serious personal injury.

APPLICATION INFORMATION

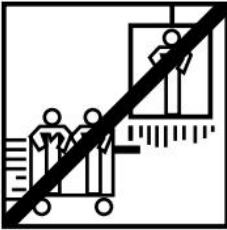

This winch is designed to move a load at ground level or up an incline. It is neither designed nor intended for hoisting.

This winch is not to be used to lift or move people.

This winch is for intermittent use due to heat build up characteristics of various components. If the end of the motor becomes uncomfortably hot to touch, stop winching and allow the motor to cool down.

SAFETY PRECAUTIONS

Throughout this manual, you will find notations with the following headings:

▼ Danger

: Indicates an imminently hazardous situation which, if not avoided, will result in death or serious injury.

▼ Warning

: Indicates a potentially hazardous situation which, if not avoided, could result in death or serious injury.

▼ Caution

: Indicates a potentially hazardous situation which, if not avoided, may result in minor or moderate injury. This notation is also used to alert against unsafe practices.

The following symbols on the product and in the Owner's Manual are used:



Read Owner's Manual



Always Use Handsaver



Keep clear of winch, wire rope and hook while operating

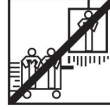

Never use winch to lift or move people



Never use winch to hold loads in place

Note: Indicates additional information in the installation and operation procedures of your winch.

Please Note: Winch is designed primarily for intermittent applications. This winch is not designed to be used in industrial or hoisting applications.

Always use handsaver on the hook.

Keep clear of winch, wire rope and hook while operating.

Never use winch to lift or move people.

Never use winch to hold loads in place.

GENERAL SAFETY INFORMATION

Your winch is a very powerful machine. If used unsafely or improperly, it could result in property damage or personal injury.

Warning

The responsibility for safe installation and operation of the winch and prevention of personal injury and property damage ultimately rests with you, the operator. There is no substitute for the use of good judgement and caution in operating a winch.

Warning

The wire rope may break before the winch stalls. For heavy loads, use a pulley block to reduce the load on the wire rope.

1. Maximum working load capacity is on the wire rope layer closest to the drum. **DO NOT OVERLOAD. DO NOT ATTEMPT PROLONGED**

PULLS AT HEAVY LOADS. Overloads can damage the winch and/or the wire rope and create unsafe operating conditions. **FOR LOADS OVER 1/2 RATED CAPACITY, WE RECOMMEND THE USE OF THE OPTIONAL PULLY BLOCK TO DOUBLE LINE THE WIRE ROPE**(Figure 1). This reduces the load on the winch and the strain on the wire rope approximately 50%. Attach hook to load bearing part. The vehicle engine should be running during winch operation. If considerable winching is performed with the engine off, the battery may be too weak to restart the engine.

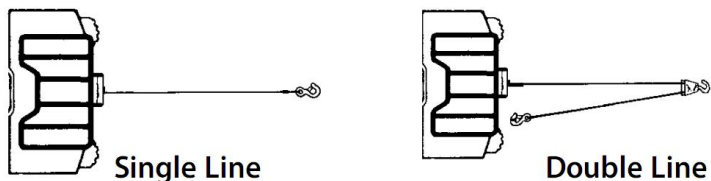
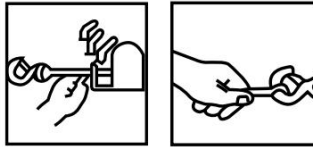

Figure 1.

2. AFTER READING AND UNDERSTANDING THIS MANUAL, LEARN TO USE YOUR WINCH. After installing the winch, practice using it so you will be familiar with it when the need arises.
3. DO NOT “move” your vehicle to assist the winch in pulling the load. The combination of the winch and vehicle pulling together could overload the wire rope and the winch.
4. **ALWAYS STAND CLEAR OF WIRE ROPE, HOOK AND WINCH. IN THE UNLIKELY EVENT OF ANY COMPONENT FAILURE IT’S BEST TO BE OUT OF HARM’S WAY.**
5. Inspect wire rope and equipment frequently. A frayed wire rope with broken strands should be replaced immediately.
6. Use heavy leather gloves when handling wire rope. Do not let wire rope slide through your hands.
7. Never winch with less than 5 turns of wire rope around the winch drum since the wire rope end fastener may NOT withstand full load.
8. Never put your finger through the hook. If your finger were trapped in the hook, you could lose your finger.



9. **ALWAYS USE THE HAND SAVER** When guiding the wire rope in or out.(See Figure 2).
10. **NEVER HOOK THE WIRE ROPE BACK ONTO ITSELF** because you could damage the wire rope. Use a nylon sling (Figure 3).

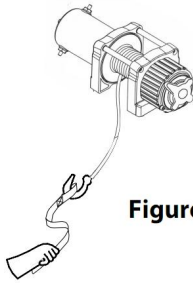

Figure 2

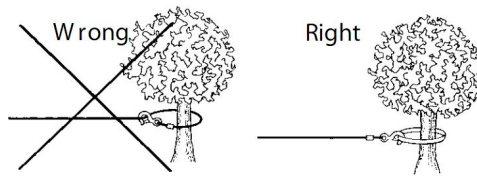

Figure 3

11. It's a good idea to lay a heavy blanket or jacket over the wire rope near the hook end when pulling heavy loads (Figure 4). If a wire rope failure should occur, the cloth will act as a damper and help prevent the rope from whipping.

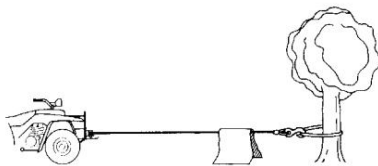

Figure 4

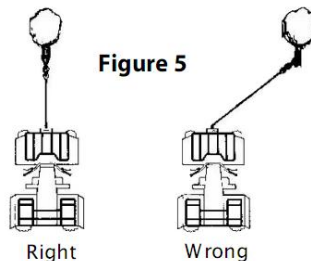

Figure 5

12. **AVOID CONTINUOUS PULLS FROM EXTREME ANGLES** as this will cause the wire rope to pile up on one end of the drum.This can jam the wire rope in the winch, causing damage to the rope or the winch.
13. **NEVER OBSCURE THE WARNING INSTRUCTOIN LABELS.**
14. Always operate winch with an unobstructed view of the winching

operation.

15. Equipment such as tackle, hooks, pulley block, straps, etc. should be sized to the winching task and should be periodically inspected for damage that could reduce their strength.
16. NEVER RELEASE FREESPOOL CLUTCH WHEN THERE IS A LOAD ON THE WINCH.
17. NEVER WORK ON OR AROUND THE WINCH DRUM WHEN WINCH IS UNDER LOAD.
18. DO NOT OPERATE WINCH WHEN UNDER THE INFLUENCE OF DRUGS, ALCOHOL OR MEDICATION.
19. ALWAYS DISCONNECT WINCH POWER LEADS TO BATTERY BEFORE WORKING IN OR AROUND THE WINCH DRUM so that the winch cannot be turned on accidentally.
20. When moving a load, slowly take up the wire rope slack until it becomes taut. Stop, recheck all winching connections. Be sure the hook is properly seated. If a nylon sling is used, check the attachment to the load.
21. When using your winch to move a load, place the vehicle transmission in neutral, set vehicle brake, and chock all wheels.
22. DO NOT USE THE WINCH TO HOLD LOADS IN PLACE. Use other means of securing loads such as tie down straps.



23. USE ONLY FACTORY APPROVED SWITCHES, REMOTE CONTROLS AND ACCESSORIES. Use of nonfactory approved components may cause injury or property damage.
24. DO NOT MACHINE OR WELD ANY PART OF THE WINCH. Such alterations may weaken the structural integrity of the winch.
25. DO NOT CONNECT WINCH TO EITHER 110V AC HOUSE CURRENT OR 220V MAINS AS WINCH BURNOUT OR FATAL SHOCK MAY OCCUR.

26. Never allow shock loads to be applied to winch or wire rope.
27. Use a caution when pulling or lowering a load up and down a ramp or incline. Keep people, pets and property clear of the path of the load.
28. The switch assembly must be kept free of dirt and moisture to ensure safe operation.
29. To prevent unauthorized use of the winch, remove pendant control and store in a clean dry area such as the glove box.

PRODUCT SPECIFICATION

Model SPEC.	P2000-1	P3000-1C	P4000-1D	P4000-1W
Voltage	12VDC	12VDC	12VDC	12VDC
Rated power	0.95HP	1.3HP	2.2HP	2.2HP
Gear ratio	153: 1	153: 1	128.2: 1	128.2: 1
Length of wire	1.8m	1.8m	1.8m	1.8m
Rope	Steel , 5/32inch * 39ft	Steel , 3/16inch * 39ft	Steel , 1/4inch * 39ft	Synthetic , 1/4inch * 39ft
IP Rating	55	55	55	55

Package Content

Model Parts	P2000-1	P3000-1C	P4000-1D	P4000-1W
Electric Winch	1	1	1	1
Control Box	×	1	1	1
Wireless Remote Control	×	1	1	1
Handle controller	1	1	1	1
Roller Fairlead	1	1	1	1
Mounting Bracket	1	1	1	1
Clevis Hook	1	1	1	1
Red Band	1	1	1	1
Screw Kit	1	1	1	1
Manual	1	1	1	1

PRODUCT ASSEMBLY INSTRUCTIONS

MOUNTING YOUR WINCH

MOUNTING KITS

THE MANUFACTURE RECOMMENDS THE USE OF A MOUNT KIT FOR SECURE MOUNTING TO YOUR VEHICLE. ATV Winch mounting kits are normally included in the winch package. If you choose not to purchase a mounting kit, your winch needs to be attached to a secure and flat mounting location. Note that your winch may not be able to be operated safely without some equipment included in the kit.



Caution

This winch must be mounted with the wire rope in the underwound direction (Figure 6).

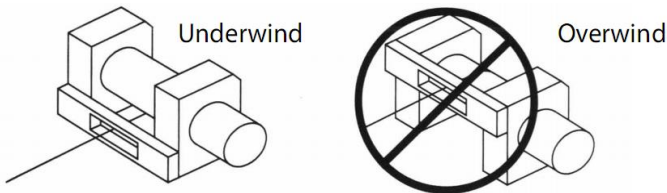

Figure 6

Note: It is possible and not uncommon or discouraged to mount your winch in attitudes other than those shown in this installation manual.

While mounting attitude is at your discretion, always remember that your winch is to be operated with the wire rope in an underwound orientation on the wire rope drum (Figure 1). Your winch is designed to ROPE IN AND ROPE OUT in one direction. Do not attempt to reverse the operation of your winch.

WINCH INSTALLATION

Note: When installing a winch, your installation may vary slightly from the instructions and diagrams that follow, depending upon your vehicle, winch, mounting kit or structural support.

▼ Warning

Before you start your winch installation, disconnect the vehicle ground and positive leads from the battery.

MINIMUM ELECTRICAL REQUIREMENTS

Be sure to select the appropriate battery or power supply to handle this winch. If the winch is in heavy use, an auxiliary battery and heavy duty alternator are recommended.

INSTALLATION PROCEDURE:

STEP (1)

Install mounting kit or prepare a flat, secure mounting location for winch to make sure the motor, drum and gear box are aligned correctly. Carefully follow the instructions included with the mounting kit.

▼ Warning

Be sure structural support is strong enough to support rated capacity of the winch.

Note: If you don't have a mounting kit, you will need to drill holes in the structural support. Be sure that your structural support is at least 3/16" (5mm) thick.

▼ Warning

If different length bolts, nuts, washers and other hardware are required for your installation, always use hardware that equals or exceeds the strength grade of the supplied hardware.

Step (2)

Position the winch over the holes in the mounting kit or structural support.

Warning

As you position the winch, make sure that the wire rope winds in the proper rotation on the drum. Failure to operate the winch in the proper direction can cause the winch brake (if equipped) to operate improperly, and /or cause the winch to fail.

Step (3)

Secure winch (figure 7) to mounting kit or structural support using bolts, lock washers and square nuts supplied with winch.

Figure 7 - Winch mounting

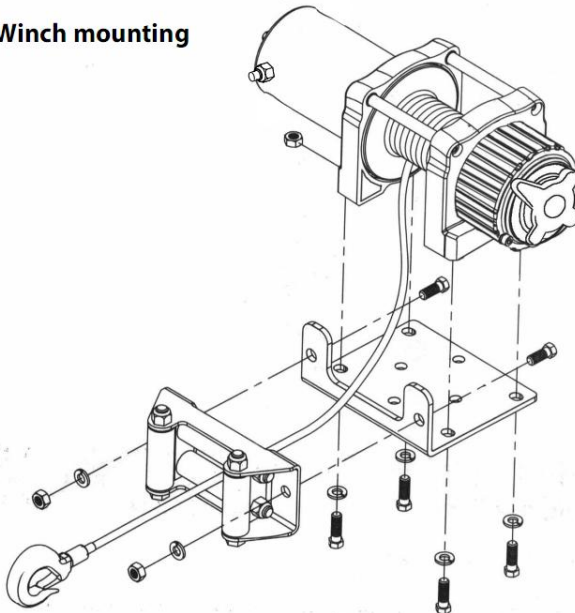

Step (4)

Secure roller fairlead (Figure 7) to mounting plate or structure support using hardware supplied or by using two (2) M8x 20L 8.8 Grade Tensile steels bolts.

⚠ Warning

Be sure that both the mounting plate and winch hardware have been properly tightened.

⚠ Caution

No part of the vehicle (skidplates, wiring, auxiliary lights, tires, etc.) should impede the operation of your winch. When mounting, check all vehicle and winch parts for free operation. Be sure that the winch mounting location does not significantly reduce ground clearance.

SOLENOID BOX MOUNTING

1. The solenoid box disconnects your winch from battery when the vehicle is turned off.
2. The solenoid box should be mounted close to the battery and in a location that is as clean and dry as possible.
3. Ensure the solenoid box location selected provides sufficient clearance from all metal structures, such as frame tubes.

TOGGLE SWITCH INSTALLATION

APPLICATIONS: ATV SERIES

▼ Caution

When attaching wires to the motor or solenoid terminals, hold the inner nut with a wrench while tightening the outer nut with a second wrench. Do not allow terminals to rotate in their housings. Rotation may cause internal wire breakage or part misalignment (Figure9).

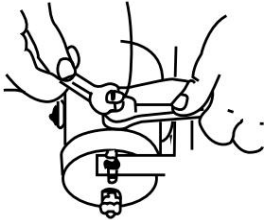

Figure 9—Proper Terminal Tightening

Step (1)

Check to ensure that the vehicle ground and positive leads from the battery are disconnected before performing any electrical work.

▼ Danger

DO NOT ATTEMPT TO INSTALL WIRING WHEN THE BATTERY IS CONNECTED. Automotive batteries contain flammable and explosive gases. Wear eye protection during installation and remove all metal jewelry. Do not lean over battery while making connections.

Step (2)

Route the wiring harness, attaching the harness to hard points on the vehicle with cable ties.

Note: When routing the wires, the appropriate terminals should be located near the battery, switch mounting point, and winch. Your installation requirements will vary depending upon your vehicle and winch. Make sure wires are long enough to reach the battery, switch mounting point and winch.

Warning

Ensure that wiring harness does not interfere or come in contact with any hot or moving engine, suspension, steering, braking or exhaust parts.

Step(3)

Using the supplied clamps, bracket and hardware mount toggle switch in a convenient location. See Figure 10.

Figure 10

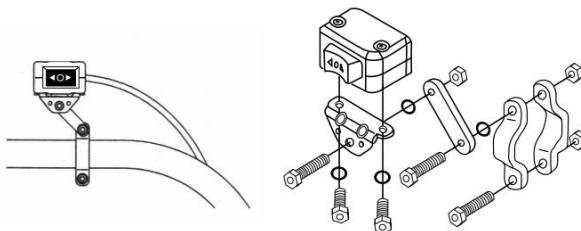

Caution

ALWAYS USE THE TOGGLE SWITCH MOUNTING

BRACKET, SCREWS, AND LOCK NUTS PROVIDED. Screw lengths are sized for correct penetration into switch box. Excess penetration may result in short circuits that could lead to wire over heating.

Step (4)

It is recommended that the switch be installed on the left handlebar.

WIRING INSTALLATION

Step (1)

Route the short red and black color coded wires to the motor.

Route the long red and black color coded wires to the battery.

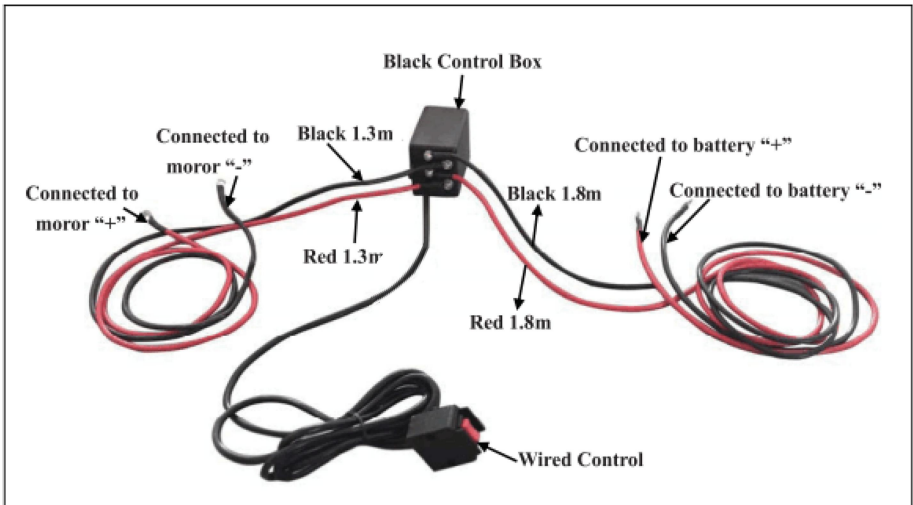
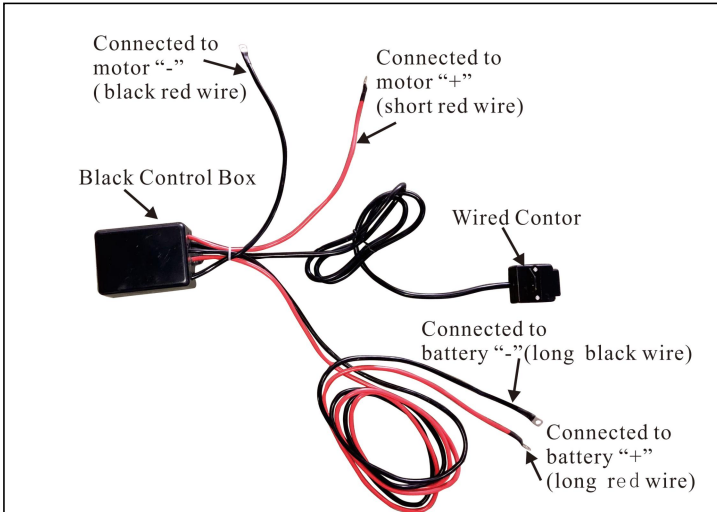

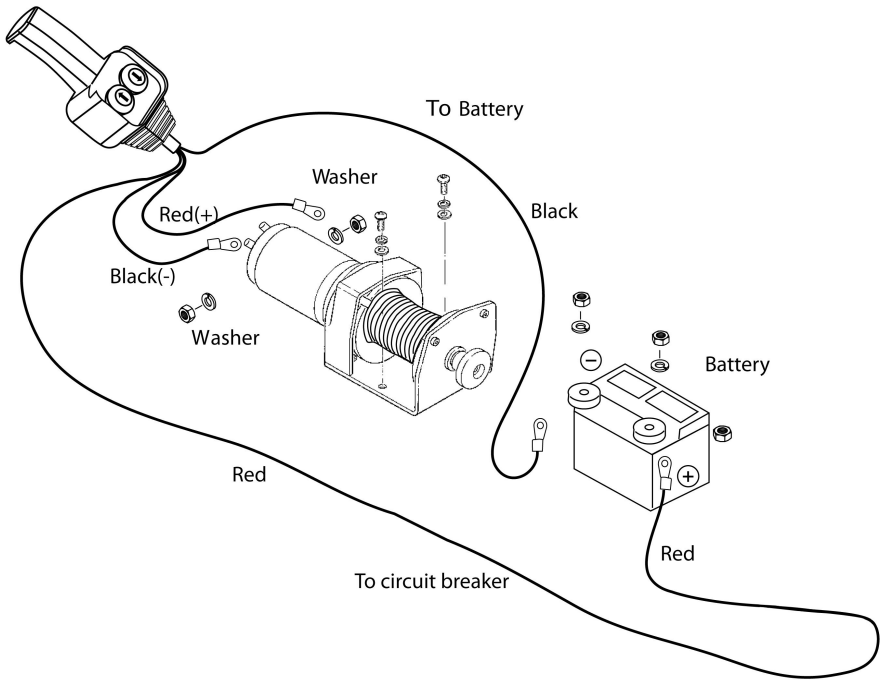

Step(2)

**Check that all wiring is clear of sharp edges and pinch points.
 Secure loose wiring with tie wraps or electrical tape.
 Never leave the switch plugged in when winch is not in use.**

PRODUCT INSTRUCTIONS

Warning

Before testing winch operation, be sure to reel off approximately two feet of wire rope.

TEST DRIVE

1. Double check that all wiring is correct and that there no exposed terminals that can short to the vehicle frame.
2. Turn the ignition key to the ON position. Check winch for proper operatoin.

FREE SPOOL OPERATION

Pull and turn the clutch knob to the “Free ” position.If there is a load on the wire rope, the clutch knob may not pull out easily. **DO NOT FORCE THE CLUTCH KNOB.** Release tension on the clutch by jogging out some of the wire rope. Release the clutch and pull out the wire rope and secure to anchor or load. Check that there are at least five 5 turns of wire rope left on the drum. Re-engage the drum by returning the clutch knob to the “Engaged” position. Activate the winch in Cable Out momentarily to check drum rotation direction. If the drum rotates in the wrong direction, recheck your wiring.

Caution: Turn the clutch knob according to the arrows and instructions on it to engage or disengage the winch gears.

Caution: Clutch must be fully engaged before winching. Never engage clutch knob while drum is turning.

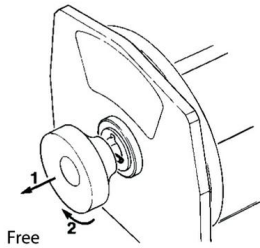

⚠ CAUTION

If the winch motor stalls, do not continue to apply power.

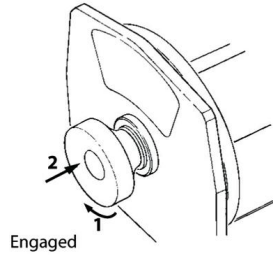

ENGAGED:

FREESPOOL:



WIRE ROPE

1. The life of the wire rope is directly related to the care it receives. The wire rope on a new winch, and any replacement ropes, should be respoled under a minimum of 100lb load before using the winch. Failure to do this will result in wire rope damage. Inspect wire rope before use. Mashed, pinched, frayed or kinked areas severely reduce the load-carrying capacity. Replace damaged wire rope.

2. Prevent kinks before they occur.

(a) This is the start of a kink. At this time, the wire rope should be straightened.

(b) The wire rope was pulled and the loop has tightened to a kink. The wire rope is now permanently damaged and should not be used.

(c) The result of kinking is that each strand pulls a different amount causing the strands under greatest tension to break and reduce load capacity of the wire rope.

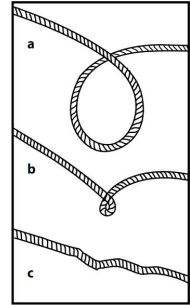

3. When it is necessary to respool the wire rope under no load after use, hold the remote switch lead in one hand and the wire rope in the other. Start from as far from the vehicle as the remote switch will allow, activate the switch, walk in several feet of rope and release switch. Repeat the process. Always release the switch before your hand comes within four feet from the fairlead (if fitted).

4. Be sure the wire rope is distributed evenly and tightly on the drum. A loosely wound drum allows the wire rope to work its way down into the layers of wire rope on the drum and become wedged.

5. It is not advisable to grease or oil the wire rope due to dirt contamination that will reduce the wire rope life.

REPLACE THE WIRE ROPE

1. If the wire rope has become worn or is beginning to show signs of strands breaking it must be replaced before being used again. To do this, remove the defective rope by free spooling. Remove the bolt on the drum and release the rope.

2. Insert the end of the new rope and secure bolt tightly.

- Engage the clutch and re-spool the new rope on the drum keeping tension on the rope as it spools. Ensure that the rope is respooling in the underwind position.

Warning Only replace the wire rope with the identical replacement part recommended by the manufacturer.

PREPARING THE WEINCH

Danger Wear heavy leather gloves when handling wire rope, even with gloves on. When handling the hook, always use handsaver (See Figure 12.) Never put your fingers into your hook. Placing finger(s) in hook could result in injury.



Figure 12

- When anchoring the pulling vehicle, set the parking brake and block or chock the wheels. Keep the vehicle's foot brake depressed and place automatic and manual transmissions in neutral.



Warning Inspect switch and wiring for cracks, pinched spots, frayed wire, or loose connections. A damaged, shorted lead could cause the

winch to run as soon as it is plugged in.

1. When using the remote switch inside a vehicle, always pass it through a window to avoid pinching the wire in the door.

WINCHING

▼ Danger

Never touch the wire rope or hook while they are in tension or under load. Even at rest, the winch may have the wire rope in tension. Never guide a wire rope under tension onto the drum with your hands (See Fig. 13).

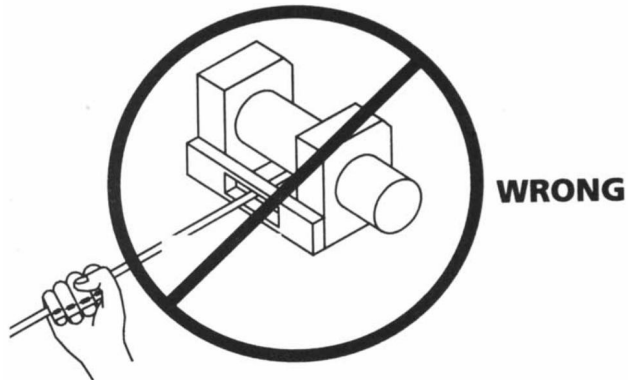

Figure 13

1. Winch with at least five wraps of wire rope around the winch drum. With fewer wraps, the wire rope could pull loose from the drum under load.
2. When pulling a load, place a blanket, jacket or tarpaulin over the wire rope near the hook end (see Fig 14). This will slow the snap back of a broken wire rope and help to prevent serious injury. Raise hood to protect windshield.

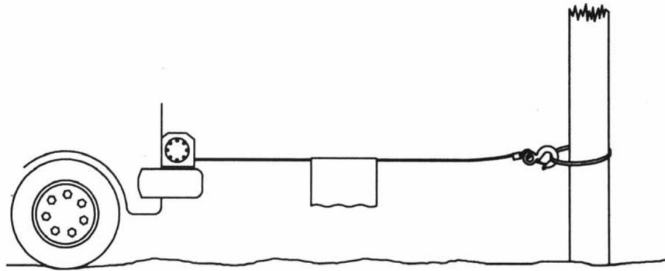

Figure 14

Warning

Note the winch's rated capacity and do not exceed it.

Warning

When the load exceeds the maximum rated pull of the winch, the external circuit breaker will automatically shut down the winch. To reset the circuit breaker release the switch button. Note the winch will not be able to restart normally until the motor heat built up from the excess strain cools down.

1. Double line with a pulley block (see Fig.15) to reduce the load on the winch, wire rope and battery. Double lining will also reduce winch line speed. Be sure all equipment used meets the winch's maximum line pull rating. When double-lining, pulley blocks should be rated to a minimum of two times the winch's line pull rating.

WINCHING

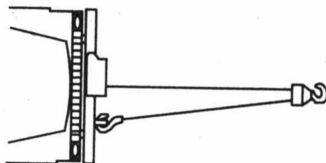

Figure 15

- 1.If you install a tow hook for double lining, it should be attached to the vehicle frame.
- 2.Equipping the winch with a fairlead will reduce wear on the wire rope during angle pulls.

3. Pull as straight as possible to reduce the buildup of wire rope on one end of the drum.

4. The vehicle engine should be running during winch operation. If considerable winching is performed with the engine off, the battery may be too weak to restart the engine.

▼ Caution

Use a pulley block to avoid winching at sharp angles.

Uneven layering will cause serious damage to the winch and wire rope. It can be corrected by securing load, spooling out the wire rope and repositioning it to the opposite end of the drum.

▼ Danger

Do not disengage clutch under load, if your winch is equipped with a freespool clutch, be certain that there is no tension on the wire rope when you disengage the clutch. Before winching a load, be sure the clutch is fully engaged.

▼ Warning

Use the winch to move the load. Do not attempt to assist the winch by moving the vehicle. The combination of the winch and vehicle pulling could overload the wire rope and the load could break the winch.

▼ Danger

Never rely on the winch to hold a load in place. None of our winches are designed for load-holding applications and may unwind or fail due to shock loading as the load is being transported. The load should be secured by other means, and the winch hook detached from the load.

RIGGING

▼ Warning

Take your time when rigging and include a reasonable factor

for safety. Improper rigging can result in damage to vehicle and equipment. It can also cause injury.

1. Never handle the wire rope or rigging while anyone else is at the control switch.
- 2.

Warning Use a nylon sling when attaching the wire rope to an anchor point. Do not attach the hook back on to the wire rope. Doing so can cause the wire rope to break.

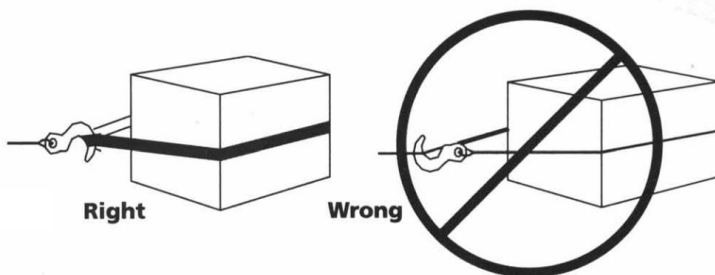
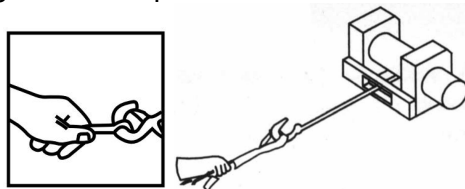

Figure 16

Warning Always use the handsaver (see Fig. 17). Do not hold the hook with your hand. This is important not only when reeling wire rope in but also when removing the wire rope from the winch under power.

Figure 17



3. Run the winch intermittently to take up wire rope slack. When using a pulley block, be sure the wire rope is running properly in all pulleys before applying a load.

Warning Do not re-engage clutch while winch is running.

Warning

Always operate winch with an unobstructed view of the winching operation. Never obscure warning and instruction labels.

RIGGING

3. Figure 18 illustrate the most commonly used rigging. A nylon sling is used to protect the tree when it is used as an anchor, and the wire rope is attached to use the sling. The use of a chain or wire rope is not recommended due to damage it could cause to the tree.



Figure 18

4. Figure 19 illustrate a method of rigging used to obtain a mechanical advantage. The use of a pulley block almost doubles pulling line capacity. (Please note the pulley block is not included)

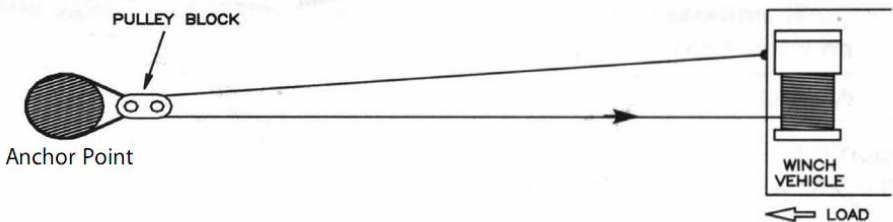

Figure 19

5. Figure 20 illustrate the use of a pulley block to change the direction of the pull. Mechanical advantage can be obtained by attaching a pulley block to the nylon sling with a shackle and running the wire rope to the

anchor point.

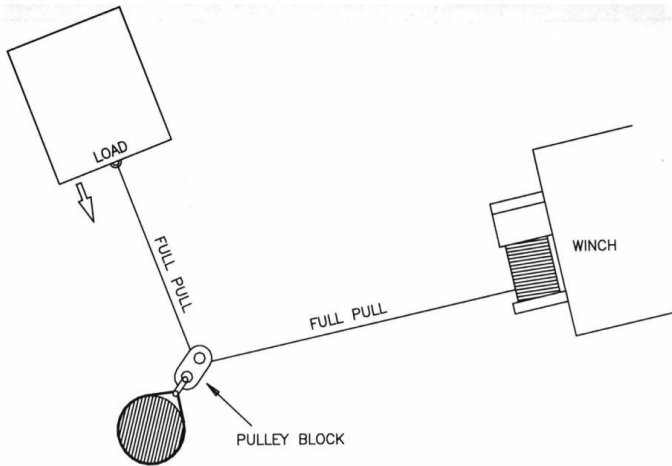

Figure 20

⚠ Caution

Equipment such as tackle, hooks, pulley blocks, straps, etc. should be properly sized and rated and should be inspected periodically for damage that could reduce their strength.

MAINTAINNENCE

- 1) Periodically check the tightness of mounting bolts and electrical connections. Remove all dirt or corrosion and always keep clean.
- 2) Do not attempt to disassemble the gear box. Repairs should be done by the manufacturer or an authorized center.
- 3) The gear box has been lubricated using a high temperature lithium grease and is sealed at the factory. No internal lubrication is required.

TROUBLE SHOOTING

Symptoms	Possible Causes	Corrective Action
Motor will not operate or only in one direction	<ol style="list-style-type: none"> 1. Switch inoperative 2. Broken wires or bad connection 3. Damaged motor 	<ol style="list-style-type: none"> 1. Replace switch 2. Check for poor connections 3. Replace or repair motor
Motor runs extremely hot	<ol style="list-style-type: none"> 1. Long period of operation 2. Failed or removed overload 3. Damaged motor 	<ol style="list-style-type: none"> 1. Allow to cool 2. Replace or repair overload 3. Replace or repair motor
Motor runs, but with insufficient power or line speed	<ol style="list-style-type: none"> 1. Weak battery 2. Battery to winch wire too long 3. Poor battery connection 4. Poor ground 5. Damaged motor 	<ol style="list-style-type: none"> 1. Recharge or replace battery and check charging system 2. Keep winch within distance allowed by lead wires 3. Check battery terminals for corrosion and clean as required 4. Check and clean connections 5. Replace or repair motor
Winch runs backwards	<ol style="list-style-type: none"> 1. Motor wires reversed 2. Control wires reversed 3. Battery switch installed incorrectly 	<ol style="list-style-type: none"> 1. Check wiring 2. Check wiring 3. Check battery connections
Motor runs but drum doesn't turn	<ol style="list-style-type: none"> 1. Clutch not engaged 	<ol style="list-style-type: none"> 1. Engage clutch
Winch coasts	<ol style="list-style-type: none"> 1. Excessive load 	<ol style="list-style-type: none"> 1. Reduce load or double line
Motor operates but stops	<ol style="list-style-type: none"> 1. Excessive load/overload 	<ol style="list-style-type: none"> 1. Allow to cool

Importer: WAITCHX

Address: 250 bis boulevard Saint-Germain 75007 Paris

Importer: FREE MOOD LTD

Address: 2 Holywell Lane, London, England, EC2A 3ET

Manufacturer: Ningbo Lift Winch Manufacture Co., Ltd

Add: Xinlei Road, Yinjiang Town, Yinzhou District 315151 Ningbo, China

Made In China

UK	REP
-----------	------------

EUREP UK LTD
UNIT 2264, 100 OCK STREET, ABINGDON
OXFORDSHIRE ENGLAND OX14 5DH

EC	REP
-----------	------------

EUREP GmbH
Unterlettenweg 1a, 85051
Ingolstadt, Germany

VEVOR[®]

TOUGH TOOLS, HALF PRICE

Technical Support and E-Warranty Certificate

www.vevor.com/support