

# **VEVOR<sup>®</sup>**

**TOUGH TOOLS, HALF PRICE**

Technical Support and E-Warranty Certificate [www.vevor.com/support](http://www.vevor.com/support)

## **ELECTRIC CERAMIC HOB USER MANUAL**

We continue to be committed to provide you tools with competitive price.

"Save Half", "Half Price" or any other similar expressions used by us only represents an estimate of savings you might benefit from buying certain tools with us compared to the major top brands and does not necessarily mean to cover all categories of tools offered by us. You are kindly reminded to verify carefully when you are placing an order with us if you are actually saving half in comparison with the top major brands.

# VEVOR®

TOUGH TOOLS, HALF PRICE

## Specification of Ceramic Hob

MODEL: LT2V-39

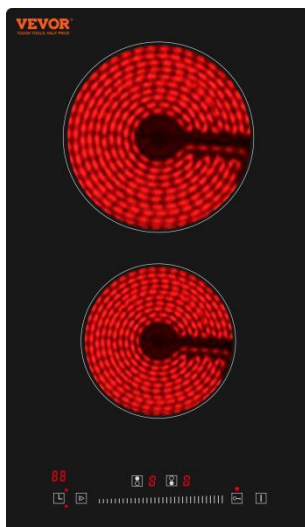

### NEED HELP? CONTACT US!

Have product questions? Need technical support? Please feel free to contact us:

 [CustomerService@vevor.com](mailto:CustomerService@vevor.com)

This is the original instruction, please read all manual instructions carefully before operating. VEVOR reserves a clear interpretation of our user manual. The appearance of the product shall be subject to the product you received. Please forgive us that we won't inform you again if there are any technology or software updates on our product.

# CONTENTS

·Model and parameters.....	2
·Important safety instructions.....	3
·Installation .....	4
·Connection to power supply.....	6
·Diagram of the radiant hob.....	6
·Instruction for use.....	6
·Safety .....	8
·Use of containers .....	9
·Cleaning and maintenance .....	10

## MODEL AND PARAMETERS

Model	LT2V-39
Voltage/Frequency	120V / 60Hz
Power (total)	1800W
Control mode	Touch
Built in size	493x273 mm
Product size	510x295 mm

**Notice: the ceramic plate is hot after cooking, please do not touch!**

### WARNING

- Repair of any faults in your cooktop must be carried out only by an Authorized Repair Service technician, otherwise the guarantee is not valid.
- The technical details and identification of the appliance are shown on the specification plate. Consult this plate before proceeding with electrical connection.
- Electrical connection must be carried out by a certified specialist familiar with official regulations.

# IMPORTANT SAFETY INSTRUCTIONS

Read all instructions carefully before using this cooktop.

Using kitchen appliances, basic safety precautions must be followed, including the following:

- This appliance must be properly installed and grounded by a qualified technician. Only connect to a properly grounded outlet. See electric preparation and connection instructions in the Installation Instructions.
- Type Y attachment: If the supply cord is damaged, it must be replaced by the manufacturer, its service agent or similarly qualified persons in order to avoid a hazard.
- Do not repair or replace any part of the cooktop unless specifically recommended. Refer service only to an authorized service center.
- Do not allow children to use this appliance unless closely supervised by an adult(Note: This appliance can be used by children aged from 8 years and above and persons with reduced physical, sensory or mental capabilities or lack of experience and knowledge if they have been given supervision or instruction concerning use of the appliance in a safe way and understand the hazards involved. Children shall not play with the appliance. Cleaning and user maintenance shall not be made by children without supervision).
- Do not store flammable materials in or near the cooktop
- Never use the cooktop to warm or heat a room.
- For personal safety, wear proper clothing.
- Use proper pan size. This appliance is equipped with one or more surface units of different sizes. Select pans with having flat bottoms large enough to cover the surface unit heating element. The use of undersized pans will expose a portion of the heating element to direct contact and may result in ignition of clothing. Proper coverage of pots and pans to burner will also improve efficiency.
- Glazed cooking utensils. Only certain types of glass, glass/ceramic, ceramic, earthenware, or other glazed pots and pans are suitable for

range-top service due to the sudden change in temperature, which may result in breakage.

- Do not soak removable heating elements. Heating elements should never be immersed in water.
- Do not cook on a broken cooktop. Contact a qualified technician immediately.
- Clean cooktop with caution. Be careful to avoid steam burns if a wet sponge or cloth is used to wipe spills on a hot cooking area. Some cleaners can produce noxious fumes if applied to a hot surface.

## **SAVE THESE INSTRUCTIONS**

# **INSTALLATION**

1. Cut a hole in the worktop of the dimension shown in the diagram below. A minimum of 50mm space should be left around the hole. The worktop should be at least 30mm thick and made of heat resistant material.

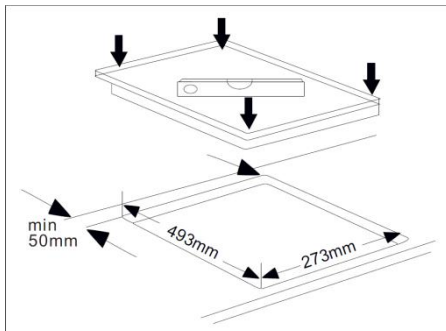

2. It is essential that the Radiant Cooktop is well ventilated and that the air intake and exit are not blocked.

Make sure the cooktop is correctly installed as shown in Figure 2.

Figure (2)

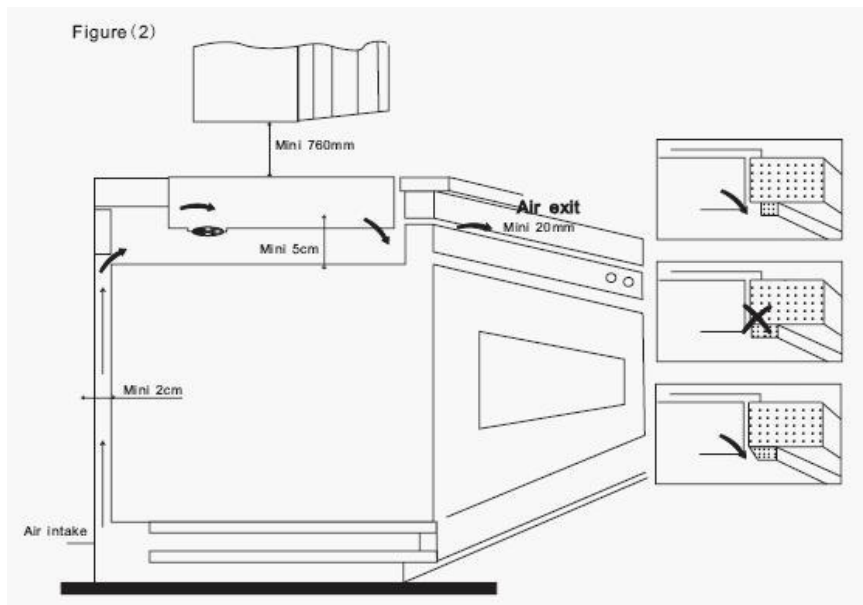

For safety the gap between the hob and any cupboard above it should be at least 760mm.

## WARNING

- (1). The Radiant cooktop must be installed by a properly qualified person We have our own qualified installers Never try to install the appliance yourself.
- (2).The Radiant cooktop must not be installed above refrigerators freezers, dishwashers or tumble dryers.
- (3).The wall and the area above the cooktop should be able to withstand heat.

## Connection to power supply:

If the cable is damaged or needs or needs replacing this should be done by

an after sales technician using the proper tools so as to avoid any accidents.

The installer must ensure that the correct electrical connection has been made and that it complies with safety regulations

The cable must not be bent or compressed

The cable must be checked regularly and only replaced by a properly qualified person.

## Electric ceramic stove failure:

No heating for 2 minutes after the gear is selected, an "E4" fault will be displayed.

Customer Service Email: [CustomerService@vevor.com](mailto:CustomerService@vevor.com)

(Please send relevant videos and pictures to our email address, and attach your Amazon order number. After confirming the problem, we will definitely give you a satisfactory solution.)

## Diagram of the radiant hob

Schematic diagram of the control panel

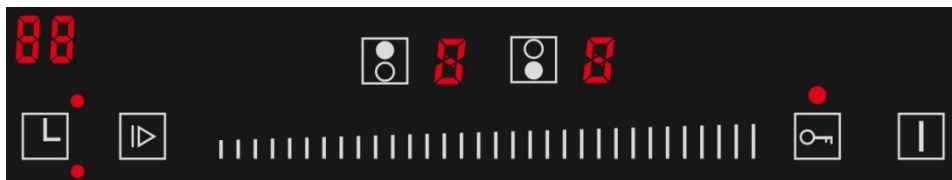

Instructions for Use

Operating the device

Place suitable cookware onto the cooker plate, The operation of both zones is the same.

Caution! Make no hot pots or pans on the keypad!

Stand-By-Modus 

Press the On / Off button. You will hear a beep and see flashing lines on the display at the upper and lower plate. If you have not selected a program within about 2 minutes, the unit will return to standby.

## Power

Press the button  for the required cooking zone.

You can slide the  to change the power levels of the relevant cooking zone. The operation of zones is the same.



up to max. 1000 W



up to max. 800 W

## Residual heat indicator

When the hob has been operating for some time, there will be some residual heat.



The residual heat indicator warns for each cooking zone separately with "H" symbol.

Timer 

After you have selected the cooking zone, please press .

Timer confirmation:

The default ones place time LED is flashing. With sliding the

 to set time of the ones place. Press the  again, the tens place time LED is flashing. With sliding the  to set time of the tens place. ( Timer max. 99 min.)

After 5 seconds no number level key be pressed, the time will start timing and the display will indicate the countdown time until to "00". If the two zones have been set different time, the display will indicate the two setting times one by one.

Timer cancellation:

By pressing onto timer key choose the zone you want to cancel the timer. Then slide the setting time to be "00", and the timer function will be



cancelled. Or you can cancel the two zones timer together by pressing



for three seconds.



Key Lock (Childlock)

To ensure the safety of children, the ceramic hob is fitted with an interlock device. To lock: hold down the “Inter lock” key for 3 seconds; the hob then goes into “Interlock” mode, the timer shows “L0” and the rest of the keys are disabled. To unlock hold down the lock key for 3 seconds and the hob will return to normal working.



Pause

Touch this button, the hob will stop working, touch again, it will be back to previous status

## SAFETY

### Safety systems

In order to protect the electronics from overheating if the control unit detects excessive heat it will switch off the hotplate closest to the sensors and the letter H will appear on the display. This hotplate can be activated when the temperature of the electronic unit returns to normal.

Each hotplate is equipped with an interior temperature limiter that switches off the hotplate if the radiant surface is heated excessively.

If any cracks appear in the radiant surface, immediately disconnect it from the mains. Do not use any part of the cooktop until a new radiant surface has been fitted.

**Automatic** The hob will automatically switch off when you did not set cooking time, forgot to switch off the hob, and did not operate the hob for two hours.

## USE OF CONTAINERS

Most stainless steel, enamel, iron, ceramic and copper pans can be used on radiant cooktops.



STAINLESS STEEL  
ENAMEL  
CERAMIC  
COPPER

Aluminum pans are not recommended as they may stain the surface, unless they have stainless steel encapsulated bottoms.

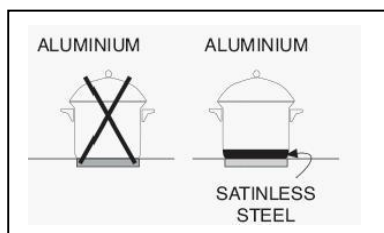

Hotplates should not be switched on without a pan on top. The base of the pan should be flat and dry. Pans that have been used on gas cookers are not normally completely flat and absorb heat badly.

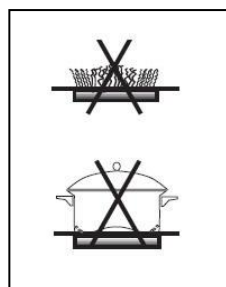

Make sure that the diameter of the pan is at least that of the hotplate.

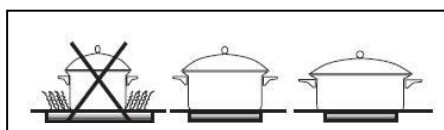

Avoid dragging pans over the radiant glass surface, as it may get scratched.  
Always lift the pan.

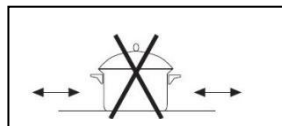

Never use tin foil or plastic containers. They may melt and fuse permanently with the radiant glass surface.

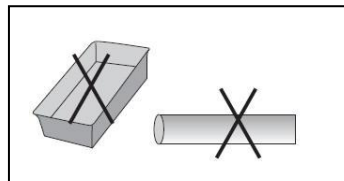

## CLEANING

**IMPORTANT: If the radiant glass surface breaks or you notice cracks in it, disconnect the equipment. Call your Repair Service Technician.**

Clean the radiant glass surface frequently, when it is cool. Never use abrasive products or pads. Clean with a damp cloth and soapy water.

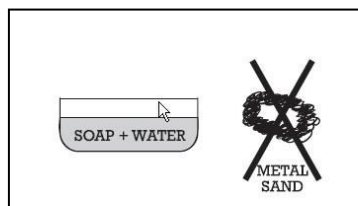

Once a week, clean thoroughly with specific products that preserve and protect radiant cooktops hobs. Scrape off stuck on stuck dirt with a scraper

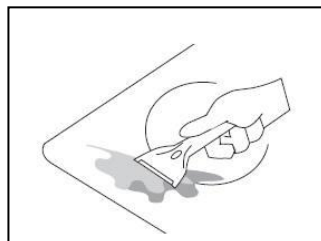

If sugar (or sugary matter) or plastic is

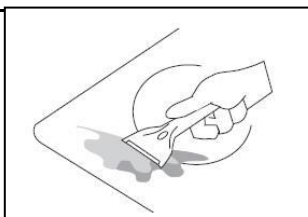

accidentally burnt on the cooktop, remove at once with the scraper while still hot. Otherwise it may leave a permanent mark.

Do not use the cooktop as a work surface. Be particularly careful with dirt or dust from vegetables, cleaning powders, etc. which may scratch the surface when pans are slid over it.

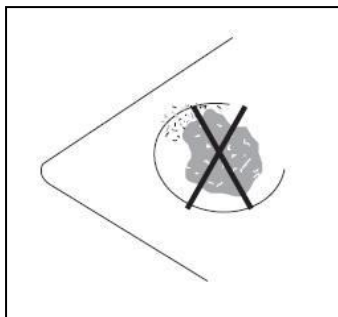

**VEVOR<sup>®</sup>**

**TOUGH TOOLS, HALF PRICE**

**Support and E-Warranty Certificate <https://www.vevor.com/support>**